

# Submersible pressure transmitter for level measurement Model LS-10, standard version

WIKA data sheet PE 81.55



## Applications

- Level measurement in rivers and lakes
- Level measurement in vessel and storage systems
- Control of sewage lift and pumping stations
- Monitoring of sewage, settling and stormwater retention basins

## Special features

- Robust
- Reliable
- Economical
- Cable supports up to 220 lbs. of strain
- Rated IP68 for permanent submersion



Submersible pressure transmitter model LS-10

## Description

### For simple measuring tasks

The model LS-10 submersible pressure transmitter has been optimised for simple measuring requirements in level measurement. It offers excellent quality, is cost-effective and reliable.

It has been designed to the current demands of the industry and has a 4 ... 20 mA output as standard, an accuracy of 0.5% and PUR cable. With IP 68 ingress protection, it is suitable for permanent level measurement up to 328 ft (100 m) water column.

### Reliable and long-lasting

The submersible pressure transmitter features a hermetically-sealed and exceptionally robust stainless steel case. The proven, fully-welded construction ensures a long service life and permanent sealing.



**Optional WIKA LevelGuard Anti-clog attachment for submersible level transmitters. For use in lift stations, wet wells and other difficult level applications. For more information request bulletin LG-1.**

## Measuring ranges

Relative pressure						
<b>bar</b>	<b>Measuring range</b>	<b>0 ... 0.25</b>	<b>0 ... 0.4</b>	<b>0 ... 0.6</b>	<b>0 ... 1</b>	<b>0 ... 1.6</b>
	Overpressure limit	2	2	3	5	8
	Burst pressure	2.4	2.4	4	6	10
	<b>Measuring range</b>	<b>0 ... 2.5</b>	<b>0 ... 4</b>	<b>0 ... 6</b>	<b>0 ... 10</b>	
	Overpressure limit	8	10	10	10	
	Burst pressure	10	10	10	10	
<b>inWC</b>	<b>Measuring range</b>	<b>0 ... 100</b>	<b>0 ... 150</b>	<b>0 ... 250</b>		
	Overpressure limit	750	750	1,100		
	Burst pressure	950	950	1,600		
<b>psi</b>	<b>Measuring range</b>	<b>0 ... 5</b>	<b>0 ... 10</b>	<b>0 ... 15</b>	<b>0 ... 25</b>	<b>0 ... 50</b>
	Overpressure limit	30	45	70	120	150
	Burst pressure	35	60	90	180	150
	<b>Measuring range</b>	<b>0 ... 100</b>	<b>0 ... 160</b>			
	Overpressure limit	150	160			
	Burst pressure	150	160			
<b>mH<sub>2</sub>O</b>	<b>Measuring range</b>	<b>0 ... 2.5</b>	<b>0 ... 4</b>	<b>0 ... 6</b>	<b>0 ... 10</b>	<b>0 ... 16</b>
	Overpressure limit	20	20	30	50	80
	Burst pressure	24	24	40	60	100
	<b>Measuring range</b>	<b>0 ... 25</b>	<b>0 ... 40</b>	<b>0 ... 60</b>	<b>0 ... 100</b>	
	Overpressure limit	80	100	100	100	
	Burst pressure	100	100	100	100	

The given measuring ranges are also available in mbar, kPa and MPa.

## Output signal

### Analogue signal

4 ... 20 mA

### Load in $\Omega$

$\leq (\text{power supply} - 10 \text{ V}) / 0.02 \text{ A} - (\text{cable length in m} \times 0.14 \Omega)$

## Voltage supply

### Power supply

DC 10 ... 30 V

## Reference conditions

### Temperature

59 ... 77 °F (15 ... 25 °C)

### Atmospheric pressure

12.5 ... 15.4 psi (860 ... 1,060 mbar)

### Humidity

45 ... 75 % relative

### Power supply

DC 24 V

## Accuracy data

### Accuracy at reference conditions

≤ ±0.5 % of span

Including non-linearity, hysteresis, zero offset and end value deviation (corresponds to measured error per IEC 61298-2).

### Non-linearity (per IEC 61298-2)

≤ ±0.2 % of span

### Non-repeatability

≤ ±0.1 % of span

### Temperature error at 32 ... 176 °F (0 ... 50 °C)

- Mean temperature coefficient of zero point  
Measuring ranges ≤ 3.6 psi: ≤ ±0.4 % of span/10 K  
Measuring ranges > 3.6 psi: ≤ ±0.2 % of span/10 K
- Mean temperature coefficient of span  
≤ ±0.2 % of span/10 K

### Long-term stability at reference conditions

≤ ±0.2 % of span/year

## Operating conditions

### Ingress protection (per IEC 60529)

IP 68

### Permissible temperature ranges

- Medium: 14 ... 122 °F (-10 ... +50 °C)
- Ambient: 14 ... 122 °F (-10 ... +50 °C)
- Storage: -22 ... 176 °F (-30 ... +80 °C)

### Immersion depth

up to 328 ft. (100 m)

### Maximum tensile strength of the cable

- without strain relief: up to 350 N
- with strain relief: up to 1,000 N

### Weight

- Level probe: approx. 0.4 lbs. (180 g)
- Cable: approx. 0.054 lbs/ft (80 g/m)
- Additional weight (accessories): approx. 1.11 lbs. (500 g)

## Electrical connection

### Short-circuit resistance

S<sub>+</sub> vs. U<sub>-</sub>

### Reverse polarity protection

U<sub>+</sub> vs. U<sub>-</sub>

### Insulation voltage

DC 500 V

### Cable lengths

Available cable lengths					
Meter (m)	1.5	3	5	10	15
	20	25	30	40	50
	60	80	100		
Feet (ft)	5	10	20	30	40
	50				

Other cable lengths on request

### Connection diagram

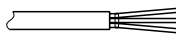
Cable outlet		
	U <sub>+</sub>	brown
	U <sub>-</sub>	green
	Shield	grey

## Materials

### Wetted parts

- Case from stainless steel
- Sensor out of stainless steel
- Protection cap from PA
- Cable from PUR

## Approvals, directives and certificates

### Approval

- CSA
- GOST-R

for further approvals, see local website



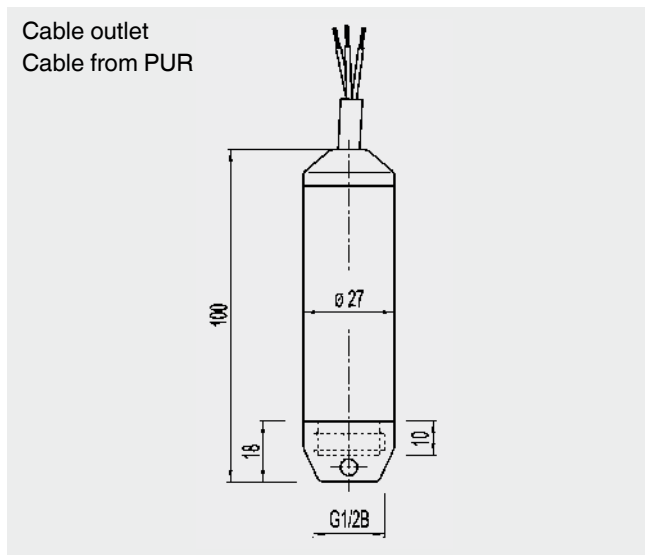

### CE conformity

EMC directive 2004/108/EC, EN 61326 emission (group 1, class B) and immunity (industrial application)

## Dimensions in mm



## Accessories

	Description	Order number
	<p><b>Cable strain relief clamp</b> The cable strain relief clamp enables easy and secure mechanical fastening of the submersible pressure transmitter's cable at the measuring point. It acts as a guide for the cable, in order to avoid mechanical damage and to reduce the tensile stress.</p>	14052336
	<p><b>Additional weight</b> The additional weight increases the dead weight of the submersible pressure transmitter. It simplifies the lowering into monitoring wells, narrow shafts and deep wells. It effectively reduces negative environmental influences on the measuring result from the measured medium (e.g. turbulent flow).</p> <p>CrNi-Stahl 316L, approx. 500 g, length (L) 130 mm</p>	14052341
	<p><b>Junction box</b> The junction box, with IP 67 ingress protection and watertight ventilation element, provides a moisture-free electrical termination for the submersible pressure transmitter. It should be mounted in dry environment or directly in the switch cabinet.</p>	14052339
	<p><b>Filter element</b> The filter element prevents dirt and moisture from entering the venting tube. The watertight diaphragm also offers a reliable protection for the submersible pressure transmitter.</p>	14052344

## Ordering information

Model / Measuring range / Cable length / Accessories

## Accessories

Dimensions in inches (mm)

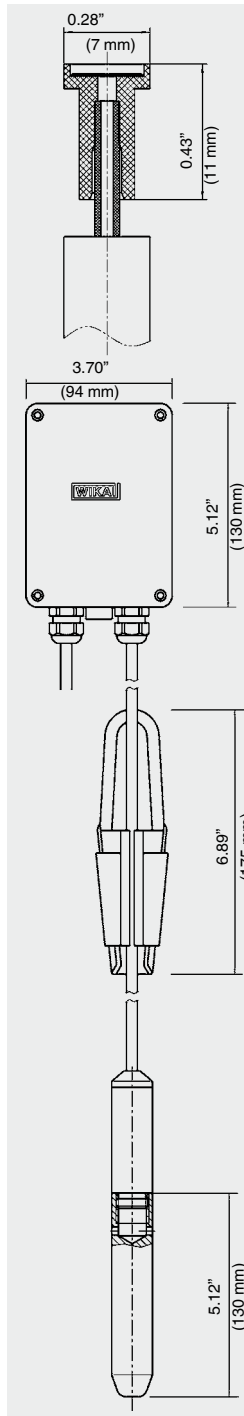

### Vent tube filter

Part# 7193131

The optional Teflon® vent tube filter protects the vent opening and protects against the entry of dirt and moisture.

### Cable junction box

Part# 2459686

The cable junction box is rated NEMA 4 / IP 67 and is suitable for mounting outside tanks or shafts or inside dry control boxes. Can be wall or DIN rail mounted.

### Cable clamp

Part# 2074257

The cable clamp secures the cable without bending or kinking that can damage the cable vent tube or outer jacket.

### Additional weight

Part# 1524399

The additional weight replaces the protective cap and helps to stabilize the transmitter in turbulent conditions. Weight: approximately 1.1 lb, 316 SS.

### Desiccant drying cartridge

part # 9836700

The desiccant drying cartridge helps prevent moisture buildup inside the vent tube.

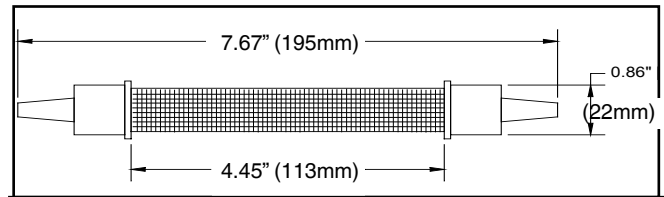

### NPT adapter

Part# 1631322

The 316 SS G1/2 adapter replaces the removable protective cap and converts the threads to 1/2" NPT male external, 1/4" female internal threads. Includes O-ring.

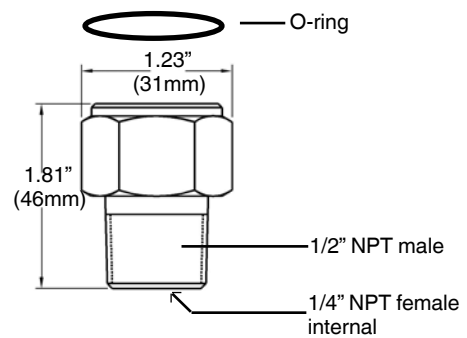

### Conduit adapter

Part# 50476114

316 SS 1/2" NPT male cable conduit adapter. Must be factory installed.

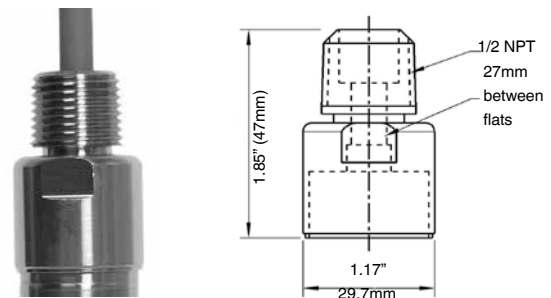

### LevelGuard Anti-clog attachment

Part # 50077091



The stainless steel LevelGuard attachment must be factory installed and calibrated.



**WIKAL Instrument, LP**

1000 Wiegand Blvd.

Lawrenceville, GA 30043

Tel: 888-WIKA-USA • 770-513-8200

Fax: 770-338-5118

info@wika.com

www.wika.com