

OEM pressure sensor For mobile working machines Model MH-4

WIKA data sheet PE 81.63



Applications

Working and control pressure measurement in:

- Construction machinery
- Agricultural and forestry machinery
- Material handling
- Municipal vehicles

Special features

- For extreme operating conditions
- Reliable and accurate
- Customer-specific solutions
- High production capacities

Description

The model MH-4 is a powerful, reliable and extremely resilient pressure sensor for mobile working machines. Even under demanding conditions, the maintenance-free sensor delivers constant, precise measured data and ensures high operational safety. Thus it is the ideal choice for OEM use.

Developed for the specific requirements in mobile working machines

The model MH-4 meets high demands and measures with high precision at temperatures between -40 and +125 °C. With its up to 3 times overload safety, the sensor withstands hydraulic pressure spikes – and is optionally available with a restrictor. Thanks to metallic shielding, the model MH-4 works interference-free at field strengths of up to 100 V/m. In addition, vibrations up to 40 g and shocks up to 100 g have no influence on the measurement quality.



OEM pressure sensor, model MH-4

Highest reliability over the entire life cycle

Whether dust, humidity, heat or mechanical stress: The model MH-4 pressure sensor is optimised for mobile use, particularly safe in operation and thus continuously dependable. The maintenance-free instrument design ensures a particularly low total cost of ownership. Even after more than 100 million load cycles, the long-term drift is still less than 0.1 % FS.

Think big – with WIKA as an OEM supplier

Secure supply chains, high quality standards and a comprehensive range of services worldwide make WIKA a reliable OEM supplier – especially for large volume orders. Model MH-4 pressure sensors are available directly, in high quantities, with commonly used electrical connections and pressure connections. Customer-specific interfaces and adaptations can be realised together – including an option for brand labelling.

Specifications

Accuracy specifications	
Accuracy	→ See "Total probable error per IEC 62828-2"
Max. measured error	→ See "Total probable error per IEC 62828-2"
Non-linearity per IEC 62828-1	≤ ±0.25 % of span (BFSL)
Total probable error per IEC 62828-2	→ See below
Long-term drift per IEC 62828-1	≤ ±0.1 % of span
Reference conditions	Per IEC 62828-1

Total probable error

Accuracy including non-linearity, hysteresis, non-repeatability, zero and span tolerance, temperature effects and long-term stability

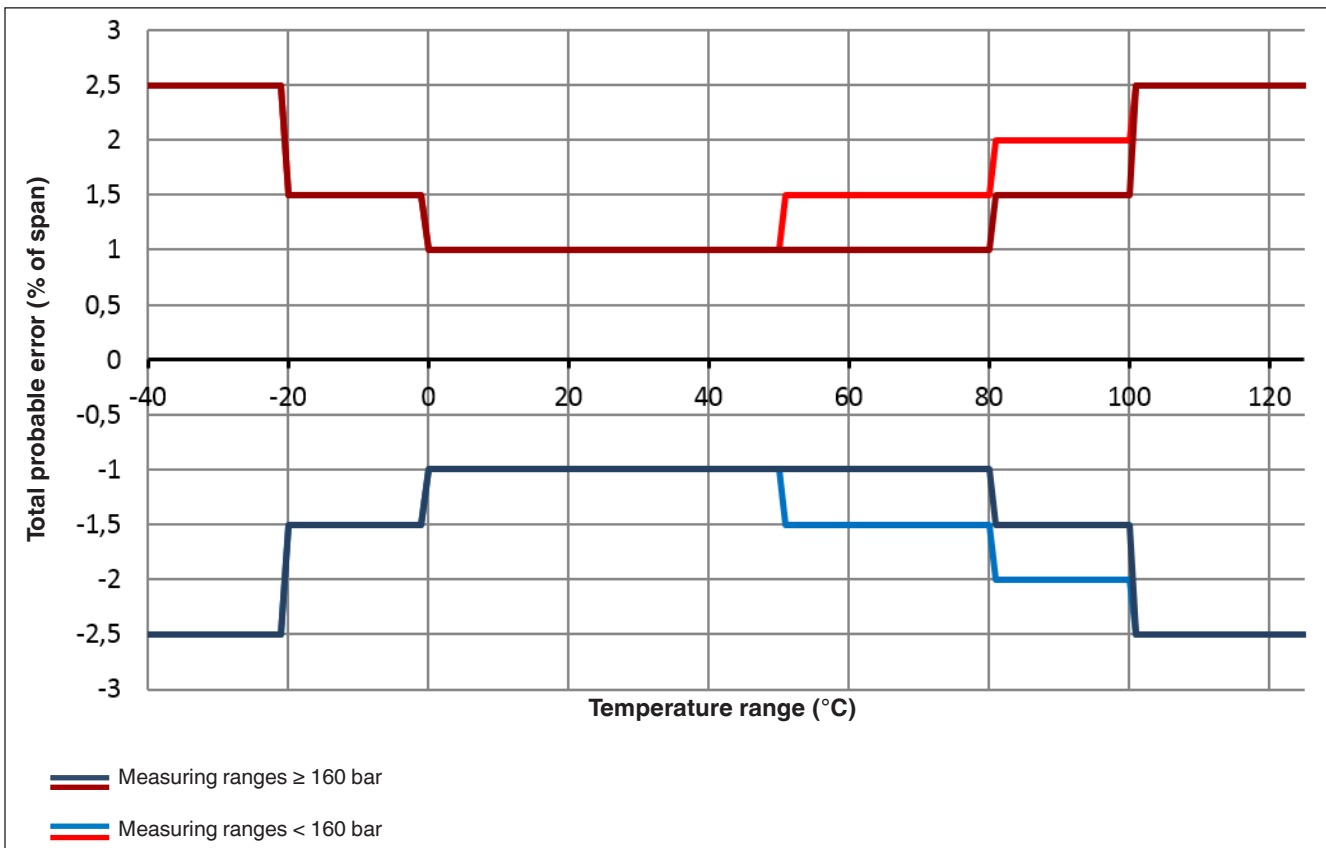

Measuring ranges, gauge pressure

bar	
0 ... 40	0 ... 250
0 ... 60	0 ... 400
0 ... 100	0 ... 600
0 ... 160	0 ... 1,000

psi	
0 ... 500	0 ... 3,000
0 ... 1,000	0 ... 5,000
0 ... 1,500	0 ... 8,000
0 ... 2,000	0 ... 10,000

Other measuring ranges on request.

Further details on: Measuring range	
Units	bar, psi, MPa
Overpressure limit	The overpressure limit is based on the measuring range. Depending on the selected process connection and sealing, restrictions in overpressure limit can result.
Measuring ranges ≤ 400 bar [≤ 5,000 psi]	3 times
Measuring range 600 bar [8,000 psi, 10,000 psi]	2 times
Measuring range 1,000 bar	1.5 times
Vacuum resistance	Yes

Process connection					
Standard	Thread size	Max. measuring range	Overpressure limit	Sealing	
DIN EN ISO 1179-2 (formerly DIN 3852-E)	G ¼ A	600 bar [8,700 psi]	858 bar [12,400 psi]	<ul style="list-style-type: none"> ■ NBR ■ FPM/FKM 	
DIN EN ISO 9974-2 (formerly DIN 3852-E)	M14 x 1.5	600 bar [8,700 psi]	858 bar [12,400 psi]		
ISO 6149-2	M14 x 1.5	600 bar [8,700 psi]	858 bar [12,400 psi]		
JIS B2351-1	G ¼ B x 10, form O with collar	600 bar [8,700 psi]	858 bar [12,400 psi]		
	G ¾ A, form O with collar	600 bar [8,700 psi]	858 bar [12,400 psi]		
SAE J514	7/16-20 UNF-2A, O-ring BOSS	600 bar [8,700 psi]	858 bar [12,400 psi]		
	9/16-18 UNF-2A, O-ring BOSS	600 bar [8,700 psi]	858 bar [12,400 psi]		
	3/4-16 UNF-2A, O-ring BOSS	600 bar [8,700 psi]	858 bar [12,400 psi]		
	7/16-20 UNF-2A, sealing cone 74°	800 bar [11,600 psi]	1,144 bar [16,500 psi]		
ANSI/ASME B1.20.1	⅛ NPT	400 bar [5,800 psi]	572 bar [8,200 psi]		-
	¼ NPT	1,000 bar [14,500 psi]	1,430 bar [20,700 psi]		
KS	PT ¼	1,000 bar [14,500 psi]	1,430 bar [20,700 psi]		
	PT ⅜	1,000 bar [14,500 psi]	1,430 bar [20,700 psi]		
ISO 7	R ¼	1,000 bar [14,500 psi]	1,430 bar [20,700 psi]		
	R ⅜	1,000 bar [14,500 psi]	1,430 bar [20,700 psi]		
EN 837	G ⅝ B	400 bar [5,800 psi]	572 bar [8,200 psi]	<ul style="list-style-type: none"> ■ Copper ■ Stainless steel 	
	G ¼ B	1,000 bar [14,500 psi]	1,430 bar [20,700 psi]		
	G ⅜ B	1,000 bar [14,500 psi]	1,430 bar [20,700 psi]		

Details must be tested separately in the respective application. The specified values for the overpressure limit serve only as a rough orientation. The values depend on the temperature, the sealing used, the selected torque, the type and the material of the mating thread and the prevailing operating conditions.

Further details on: Process connection	
Max. measuring range	→ See above
Overpressure limit	→ See above
Sealing	→ See above
Pressure port diameter	As an option, for applications that can lead to pressure spikes, a restrictor with a pressure port of 0.3 mm is available. <ul style="list-style-type: none"> ■ 2.5 mm (standard for all process connections) ■ Restrictor 0.3 mm possible (for all process connections)

Further details on: Process connection

Socket wrench suitability

Hexagon (SW 22) integrated into case

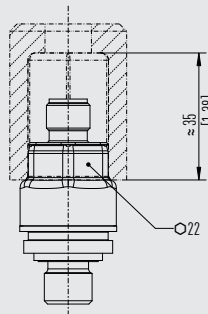

Additional hexagon (SW 27) above the process connection

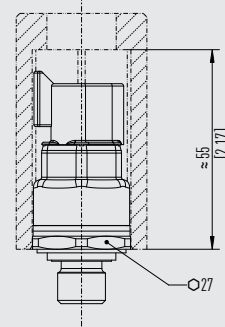

Possible restrictions

Depending on the choice of sealing on the process connection, there may be restrictions in the permissible temperature limit.

NBR	-40 ... +100 °C [-40 ... +212 °F]
FPM/FKM	-20 ... +125 °C [-4 ... +257 °F]
Copper	-40 ... +125 °C [-40 ... +257 °F]
Stainless steel	-40 ... +125 °C [-40 ... +257 °F]

Other process connections and sealings on request

Output signal

Signal type

Current (2-wire)	4 ... 20 mA
Voltage (3-wire)	<ul style="list-style-type: none"> ■ DC 1 ... 10 V ■ DC 1 ... 5 V ■ DC 0.5 ... 4.5 V
Ratiometric (3-wire)	DC 0.5 ... 4.5 V
Pulsewidth modulation PWM (3-wire)	10 ... 90 % duty cycle High level: DC 3 ... 12 V (selectable in 1 V steps) Output frequency: 0.25 ... 2 kHz (selectable in 0.25 kHz steps)

Load in Ω

Current (2-wire)	$\leq (\text{power supply} - 7.8 \text{ V}) / 0.022 \text{ A}$
Voltage (3-wire)	$\geq \text{max. output voltage} / 1 \text{ mA}$
Ratiometric (3-wire)	$\geq 4.5 \text{ k}\Omega$
Pulsewidth modulation PWM (3-wire)	$\geq 10 \text{ k}\Omega$

Signal damping

- Without
- 2 / 4 / 9 / 18 / 37 / 75 / 150 ms

Signal clamping

The range of the output signal can be limited. For this purpose, a lower and an upper signal threshold are defined in the sensor electronics. If the output signal reaches these threshold values, the sensor outputs a defined, constant signal value. Therefore, in operation, unwanted pressure or signal ranges are filtered out.

- Without
- With

Diagnostic function

Permanent errors in the sensor electronics and temporary system overpressures can be output through defined constant output signals. A permanent error signal signifies a sensor defect and cannot be reset. The temporary error signal is reset as soon as the system pressure once again lies under the error threshold. In the application, one can therefore realise an efficient system diagnosis.

- Without
- With

Output signal		
Voltage supply		
Supply voltage	Current output (2-wire), 4 ... 20 mA	DC 8 ... 36 V
	Voltage output (3-wire), DC 1 ... 10 V	DC 12 ... 36 V
	Voltage output (3-wire), DC 1 ... 5 V	DC 8 ... 36 V
	Voltage output (3-wire), DC 0.5 ... 4.5 V	DC 8 ... 36 V
	Ratiometric output (3-wire), DC 0.5 ... 4.5 V	DC 5 V ± 10 %
	Pulsewidth modulation PWM (3-wire), 10 ... 90 % duty cycle	(high level + DC 1 V) (min. DC 8 V) ... 36 V
	Max. power supply with UL approval	DC 35 V
Current supply	Current output (2-wire)	≤ 25 mA
	Voltage output (3-wire)	≤ 10 mA
	Ratiometric output (3-wire)	≤ 10 mA
	Pulsewidth modulation (3-wire)	≤ 10 mA
Overvoltage protection	DC 48 V (DC 30 V with ratiometric output signal)	
Dynamic behaviour		
Settling time per IEC 62828-1	1 ms	
Switch-on time	200 ms	

Other output signals on request

Electrical connection		
Connection type	IP code ¹⁾	Permissible temperature range
Circular connector M12 x 1, code A, 4-pin	IP67 per IEC 60529	-40 ... +125 °C [-40 ... +257 °F]
Deutsch connector DT04-2P, 2-pin		
Deutsch connector DT04-3P, 3-pin		
Deutsch connector DT04-4P, 4-pin		
Delphi connector Metri-Pack series 150, 3-pin		
Cable outlet, IP6K9K, 2- or 3-wire	IP6K9K per ISO 20653	-40 ... +110 °C [-40 ... +230 °F] ²⁾
AMP Micro Quadlok System connector, code A, 3-pin	IP67 per IEC 60529	-40 ... +125 °C [-40 ... +257 °F]
AMP Superseal connector 1.5 series, 3-pin		
AMP Seal 16 connector, cone, code A, 3-pin		
AMP Econoseal J Mark II series connector, 3-pin		
VW connector, code I, 4-pin, 2 rows		

1) The stated IP codes only apply when plugged in using mating connectors that have the appropriate IP code.

2) Max. permissible temperature for UL approval: 85 °C [185 °F]

Further details on: Electrical connection	
Connection type	→ See above
Pin assignment	→ See below
Ingress protection (IP code)	→ See "Electrical connection"
Short-circuit resistance	S+ vs. U-
Reverse polarity protection	U+ vs. U-
Insulation voltage	DC 500 V (DC 850 V optional)

Pin assignment

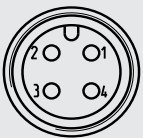
Circular connector M12 x 1, code A, 4-pin			
		2-wire	3-wire
	U+	1	1
	U-	3	3
	S+	-	4

Deutsch connector DT04-2P, 2-pin		
		2-wire
	U+	1
	U-	2
	S+	-

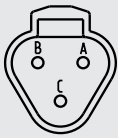
Deutsch connector DT04-3P, 3-pin			
		2-wire	3-wire
	U+	A	A
	U-	B	B
	S+	-	C

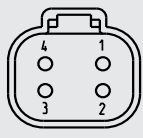
Deutsch connector DT04-4P, 4-pin			
		2-wire	3-wire
	U+	2	2
	U-	1	1
	S+	-	4

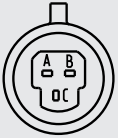
Delphi connector Metri-Pack series 150, 3-pin			
		2-wire	3-wire
	U+	B	B
	U-	A	A
	S+	-	C

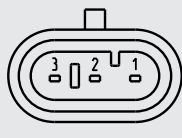
AMP Superseal connector 1.5 series, 3-pin			
		2-wire	3-wire
	U+	3	3
	U-	1	1
	S+	-	2

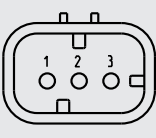
AMP Seal 16 connector, cone, code A, 3-pin			
		2-wire	3-wire
	U+	3	3
	U-	1	1
	S+	-	2

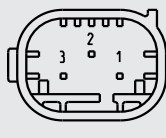
AMP Micro Quadlok System connector, code A, 3-pin			
		2-wire	3-wire
	U+	3	3
	U-	1	1
	S+	-	2

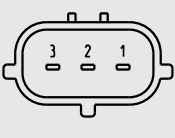
AMP Econoseal J Mark II series connector, 3-pin			
		2-wire	3-wire
	U+	1	1
	U-	3	3
	S+	-	2

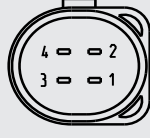
VW connector, code I, 4-pin, 2 rows			
		2-wire	3-wire
	U+	2	2
	U-	1	1
	S+	-	4

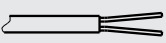
Cable outlet, IP6K9K, 2- or 3-wire			
		2-wire	3-wire
	U+	Red (RD)	Red (RD)
	U-	Black (BK)	Black (BK)
	S+	-	White (WH)

Legend

- U+ Positive power supply terminal
- U- Negative power supply terminal
- S+ Analogue output

Material	
Material (wetted)	Stainless steel 304L, PH grade steel
Material (in contact with the environment)	Stainless steel 304L, electrical connection made of highly resistant glass-fibre reinforced plastic (PBT)

Operating conditions	
Medium temperature limit ¹⁾	-40 ... +125 °C [-40 ... +257 °F]
Ambient temperature limit ¹⁾	-40 ... +125 °C [-40 ... +257 °F]
Storage temperature limit	-40 ... +70 °C [-40 ... +158 °F]
Vibration resistance per IEC 60068-2-6	40 g, 10 ... 2,000 Hz
Permanent vibration resistance per IEC 60068-2-6	10 g, 10 ... 2,000 Hz
Shock resistance per IEC 60068-2-27	100 g, 11 ms
Free fall in line with EN 60068-2-31	
Single instrument	1 m [3.28 ft]
Multiple packaging	0.5 m [1.64 ft]
Ingress protection (IP code)	→ See "Electrical connection"
Service life	100 million load cycles
EMC (HF field)	
Current output (2-wire)	100 V/m (per ISO 11452-2)
Voltage output (3-wire)	100 V/m (per ISO 11452-2)
Ratiometric output (3-wire)	100 V/m (per ISO 11452-2)
Pulsewidth modulation (3-wire)	30 V/m (per IEC 61326-2-3)



1) Depending on the choice of sealing on the process connection, the electrical connection and the UL approval, there may be restrictions in the medium and ambient temperature (→ for restrictions, see "Process connection" and "Electrical connection").

Packaging and instrument labelling	
Packaging	Multiple packaging (up to 25 pieces)
Instrument labelling (product label)	<ul style="list-style-type: none"> ■ WIKA product label, lasered ■ Customer-specific product label on request

Approvals

Logo	Description	Region
	EU declaration of conformity	European Union
	EMC directive	
	EN 61326 emission (group 1, class B) and immunity (industrial environments)	
	Pressure equipment directive	
	RoHS directive	

Optional approvals

Logo	Description	Region
	UL	USA and Canada
	Component approval	
	EAC	Eurasian Economic Community
	EMC directive	

Manufacturer's information and certificates

Logo	Description
-	MTTF: > 100 years
-	China RoHS directive

→ For approvals and certificates, see website

Dimensions in mm [in]

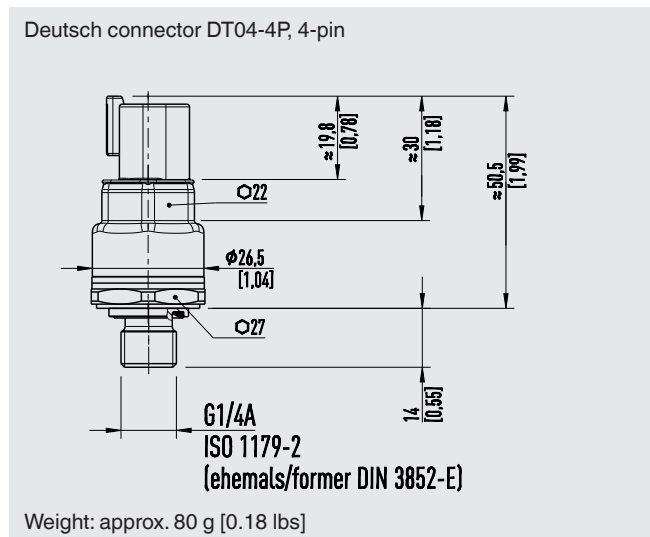
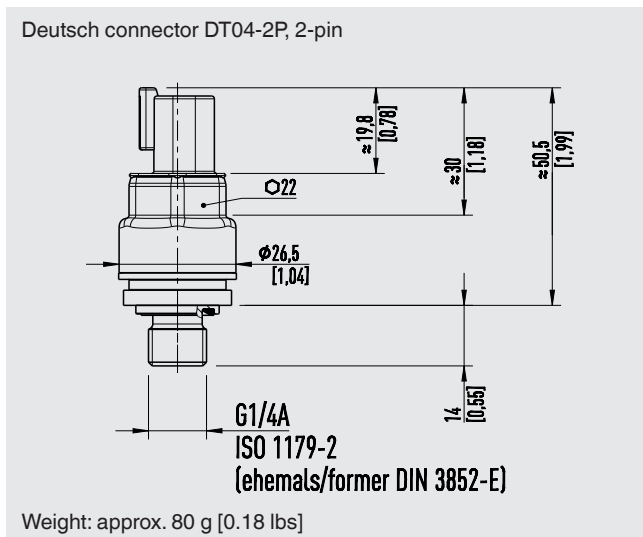
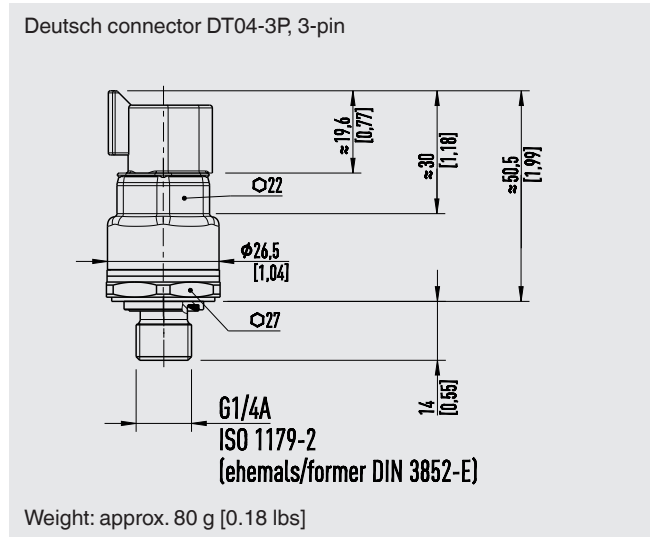
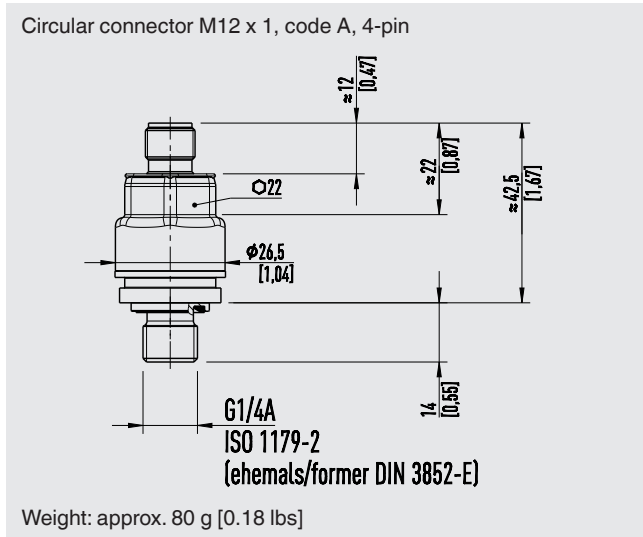

Delphi connector Metri-Pack series 150, 3-pin

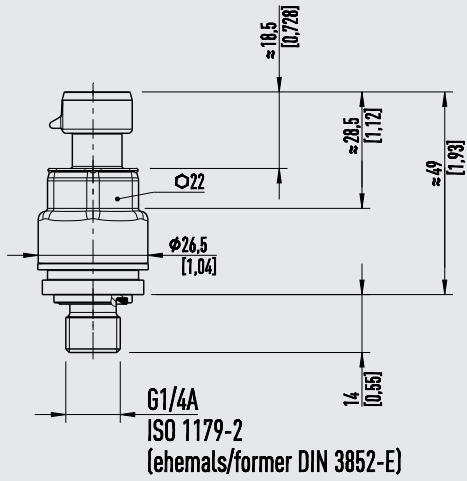

Weight: approx. 80 g [0.18 lbs]

AMP Superseal connector 1.5 series, 3-pin

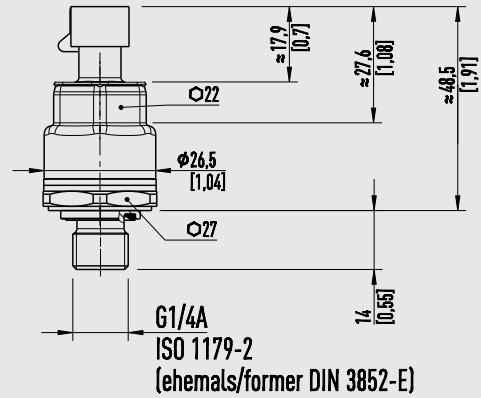

Weight: approx. 80 g [0.18 lbs]

AMP Seal 16 connector, cone, code A, 3-pin

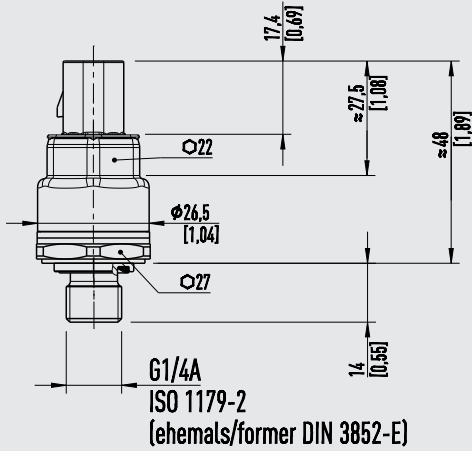

Weight: approx. 80 g [0.18 lbs]

AMP Micro Quadlok System connector, code A, 3-pin

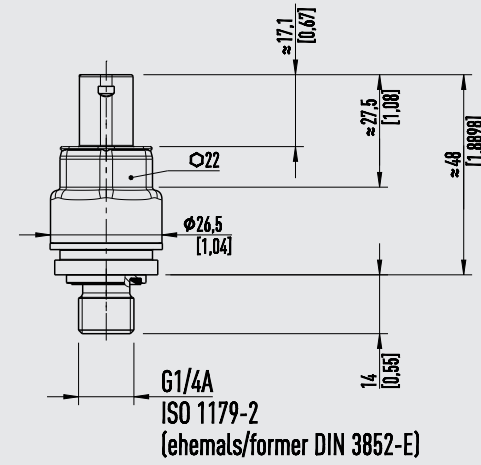

Weight: approx. 80 g [0.18 lbs]

AMP Econoseal J Mark II series connector, 3-pin

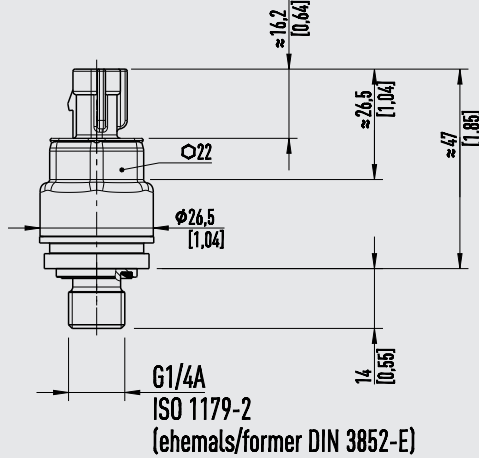

Weight: approx. 80 g [0.18 lbs]

VW connector, code I, 4-pin, 2 rows

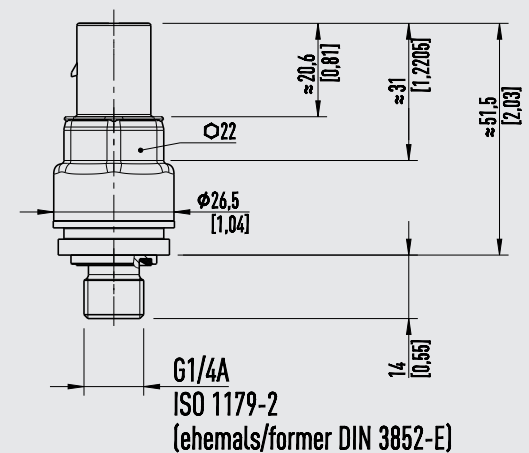

Weight: approx. 80 g [0.18 lbs]

Cable outlet, IP6K9K, 2- or 3-wire

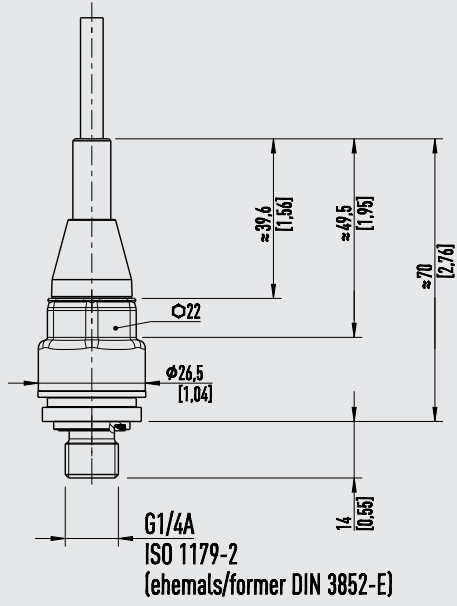

Weight: approx. 80 g [0.18 lbs]

Additional hexagon at the process connection (SW 27)

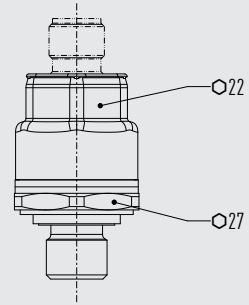

Process connections

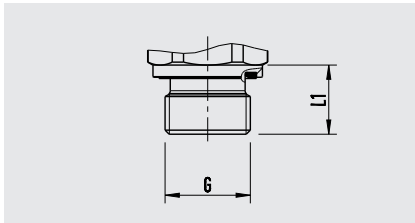

G	L1
G 1/4 A DIN EN ISO 1179-2	14 [0.55]
M14 x 1.5 DIN EN ISO 9974-2	14 [0.55]

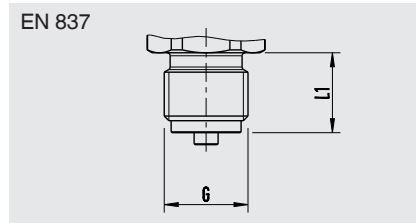

G	L1
G 1/4 B	13 [0.51]
G 3/8 B	16 [0.63]

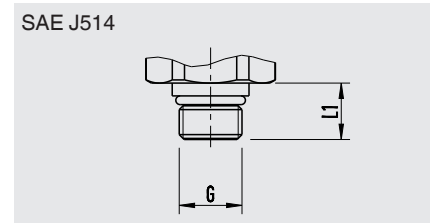

G	L1
3/4-16 UNF-2A	11.13 [0.44]
7/16-20 UNF-2A	12.06 [0.48]
9/16-18 UNF-2A	12.85 [0.51]

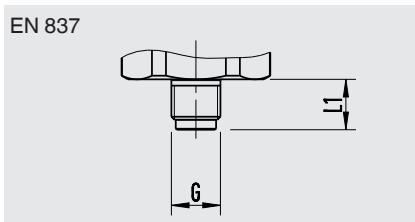

G	L1
G 1/8 B	10 [0.39]

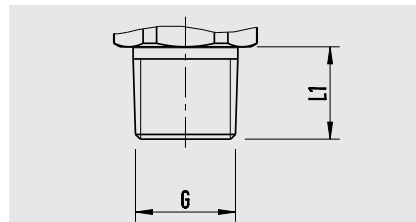

G	L1
1/8 NPT ANSI/ASME B1.20.1	10 [0.39]
1/4 NPT ANSI/ASME B1.20.1	13 [0.51]
R 1/4 ISO 7	13 [0.51]
R 3/8 ISO 7	15 [0.59]
PT 1/4 KS	13 [0.51]
PT 3/8 KS	15 [0.59]

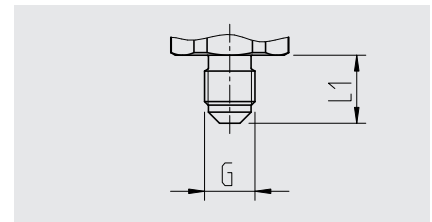

G	L1
7/16-20 UNF-2A, sealing cone 74°	15 [0.59]

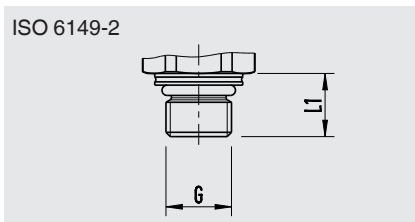

G	L1
M14 x 1.5	13.5 [0.53]

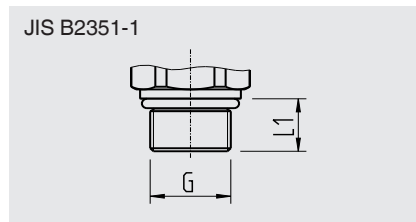

G	L1
G 1/4 B	10 [0.39]
G 3/8 A	12 [0.47]

Ordering information

Model / Measuring range / Output signal / Process connection / Sealing / Electrical connection

© 08/2018 WIKA Alexander Wiegand SE & Co. KG, all rights reserved.
The specifications given in this document represent the state of engineering at the time of publishing.
We reserve the right to make modifications to the specifications and materials.

