

Operation Manual



Warning

- When using the 6" wheel, do not use the extension shaft - the wheel may fly off the shaft and cause damage.
- Although the tachometer alone is able to achieve the higher ranges listed in the Range and Accuracy table on page 3, the wheel attachment has a maximum speed limitation of 5,000 FPM (for safety reasons).
- Laser radiation may be harmful to the human eye. Avoid direct exposure of human eyes to laser light. Eye damage can result.
- Never point the unit at another person.
- Keep out of the reach of children.
- Avoid indirect exposure via reflective materials such as glass and mirrors.



When power button is depressed, laser is active.



DT-205LR
LCD Display

DT-207LR
LED Display

Series DT-200LR Combination Contact/Non-Contact Laser Tachometers Laser-enabled precise RPM measurement up to 20 feet. The Series DT-200LR digital tachometers incorporate laser technology yet retain our hallmark rugged construction and reliable quality components. Units offer incredible value and versatility as they can operate in non-contact and contact applications. These instruments feature a field-upgradeable contact adapter for linear rate measure, conveniently allowing both non-contact and contact measurements.

All Series 200LR units come standard with a NIST traceable calibration certificate. We're confident you'll agree that these fine units are the most advanced handheld tachometers on the market!

SPECIFICATIONS

Display Range: 6 - 99,999 rpm

Accuracy: ± 1 rpm: 6 - 8,300 rpm; ± 2 rpm: 8,300 - 25,000 rpm; $\pm 0.006\%$ of reading ± 1 digit (± 6 rpm max.) 25,000 - 99,999 rpm

Display: 5 digit 0.4" (10 mm) high LED

Measuring Units: rpm (on contact using adapter, included) for YPM, mPM, FPM, IPM, and Length: YRD, m, FT and IN; Use wheel with 200L adapter

Measuring Distance: 1" (25.4mm) to 20' (6m)

Memory System: 13 readings are stored in memory and retained for 5 minutes (last, max., min., and 10 extra measurements)

Detection: Laser diode / contact

Update Time: 1 second (typical)

Power Requirement: 2 AA 1.5V batteries (Life: Approx. 25 hrs)

Operating Temperature: 32° - 113°F (0° - 45°C)

Construction: Die-cast aluminum housing

Product Weight: 0.8 lb (365 g)

Package Weight: Approx. 2 lb (.91 kg)

Approvals: CE

Dimensions: 6.6" L x 2.4" W x 1.8"H (167.5 mm x 60 mm x 46 mm); with contact adapter: Length=8.25" (209 mm)

Warranty: 2-Year

Included Accessories: Reflective tape, 2 cone adapters, funnel adapter, 3½" extension shaft, carrying case, NIST certificate, master wheel (6" cir.) & contact adapter

CONTROL PANEL

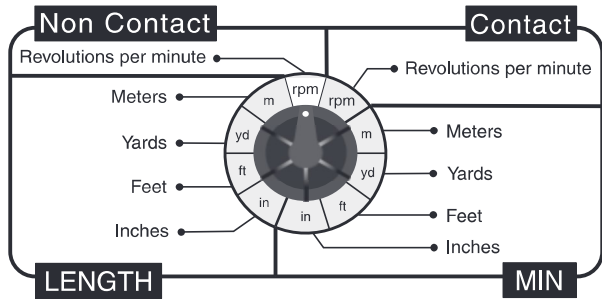

OPERATION

Non-Contact Measurement

1. Place a small piece of reflective tape (included) on the shaft or moving element (disc, pulley, etc.) whose speed is to be measured. If the element's surface is highly reflective it may need to be painted a darker color in order to ensure reliable results. If the distance to the object is less than 5" (127 mm), reflective tabs (optional) should be used instead of reflective tape.

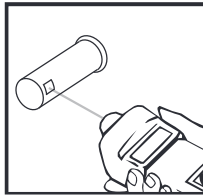

2. Aim the tachometer at the reflective tape from a distance of 5" (127 mm) to 20' (6.m).

3. Press and hold the power switch for several seconds (when power button is depressed, laser is active) to observe the display as it changes according to the speed of the shaft or rotating element (as soon as the laser hits the reflective tape, the unit will start to indicate the speed). If the beam is "on target" the RPM indicator will be flashing.

4. After observation is completed, retain the reading by releasing the power switch (to turn off laser) before removing the tachometer from its position. The last reading is displayed for a period of 5 minutes and can be extended any number of additional 5 minute increments by pressing the memory switch.

NOTE: When switching from the contact to the non-contact mode, the unit RPM will show on the display and also 5 dashes (-----). Press the power switch to cancel the dashes.

Contact Measurement

For both RPM measurements and non-RPM measurements, screw the DT-ADP-200LR Adapter (included) into the front of the tachometer.

NOTE: Hand tightening is sufficient; do not use excessive torque when mounting DT-ADP-200LR Adapter

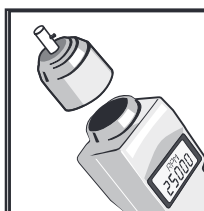

RPM Measurement

1. Place rubber cone tip on the shaft of the DT-ADP-200LR adapter. Make certain that the pin on the shaft is properly aligned with the slot on the cone's sleeve.

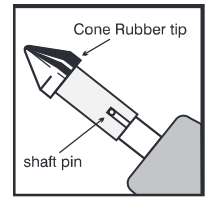

2. Bring cone into contact with the shaft. Apply only enough pressure to avoid slippage.

3. Press and hold the power switch. During engagement the display will reflect the proper RPM while the unit RPM will be flashing above the display digits.

4. Release the power switch prior to removal of tachometer from rotating object to capture the last reading.

5. After release of the power switch, the last reading (with a non-flashing RPM unit) will remain on the display and in memory for 5 minutes, and can be extended any number of additional 5 minute periods by pressing the memory switch.

Rate & Length Measurement

1. Attach the master wheel and select the desired function using the selector switch located just below the LCD display (see above).

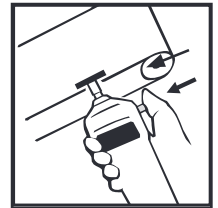

2. Press and hold the power switch; while the wheel is turning and the tachometer is measuring the selected function, the function will be indicated, and the unit of measure function will be flashing.

3. Release the power switch before disengaging the tachometer in order to capture the last reading.

4. After release of the power switch, the last, maximum, and minimum readings will be stored in memory for 5 minutes and can be extended any number of additional 5 minute periods by pressing the memory button.

NOTE: The memory will clear in 5 minutes after the release of the power switch.

For steps 1-4 described above, it was assumed that the selector switch was in the rate mode region. If the selector switch is moved from the rate mode to the count mode (length), the display will show the selected function (m, ft, yd, or in) and also 5 dashes (-----). Press the power switch to cancel the dashes and start measuring the same way as was described above. Once in the counting mode, the measurement can be stopped at any time and the last reading will be retained for 5 minutes. There is no maximum or minimum reading when in the count (length) mode.

MEMORY RECALL

The following readings are stored in memory for 5 minutes after release of the power switch:

DT-205LR:



DT-207LR:

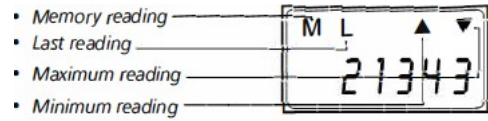

These readings can be recalled by pressing the memory switch. During measurements, ten extra readings can also be captured, stored, then recalled using the memory switch. While the tachometer is in use, simply press the memory switch each time a reading needs to be stored.

Contact Mode (Rate Functions)

When the rate functions are selected (mPM, YPM, FPM and 1PM), the memory store and recall functions are accomplished exactly as noted above.

Contact Mode (Length Functions)

When the counting functions are selected, the memory store and recall functions are accomplished in the same manner as the non-contact mode, the only exception being the maximum and minimum readings (they do not exist).

Memory Clearing

To clear the memory (for all functions), press the memory switch for approximately 5 seconds until the display shows "CCCCC". Next, press the white Power switch or Memory switch. This resets the tachometer for use.

BATTERY REPLACEMENT (2 each "M")

Low battery voltage is indicated by flashing LOW BAT on the display. Remove end cover by using a coin or appropriate screwdriver and replace both batteries. Please ensure proper polarity.

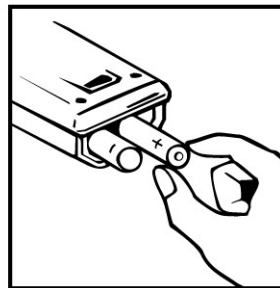
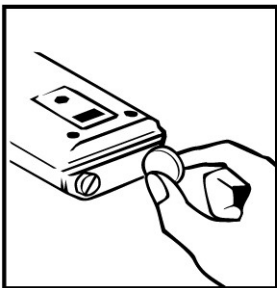

RANGE & ACCURACY

Place selector switch in the proper position. Using the DT-ADP-200LR adapter and 6" master wheel, the following industrial units of measurement are achieved:

R: REVOLUTIONS	SINGLE RANGE	ACCURACY	RESOLUTION
Non-Contact RPM (rev./min.)	6 - 8,300	± 1	1
	8,300 - 25,000	± 2	
	25,000 - 99,999	±0.006% of reading ±1 digit (or ±6 RPM max.)	
Contact RPM (rev./min.)	0.8 - 9,999.9	±0.6%	0.1
	10,000 - 25,000	±0.006% of reading ±1 digit (or ±2 RPM max.)	1
F: FEET	SINGLE RANGE	ACCURACY	RESOLUTION
F/M (feet/min.)	0.4 - 9,999.9	± 0.6	0.1
	10,000 - 12,500	± 1	1
FT (feet)	0.10 - 999.99		0.01
	1,000.0 - 9,999.9		0.1
	10,000 - 99,999		1
Y: YARDS	SINGLE RANGE	ACCURACY	RESOLUTION
Y/M (yards/min.)	0.13 - 999.99	± 0.06	0.01
	1,000.0 - 4,167.0	± 0.3	0.1
YRd (length)	0.02 - 999.99		0.01
	1,000.0 - 9,999.9		0.1
	10,000 - 99,999		1
I: INCHES	SINGLE RANGE	ACCURACY	RESOLUTION
I/M (inches/min.)	5 - 99,999	±0.006% of reading ±1 digit (or ±6 RPM max.)	1
IN (length)	1.0 - 9,999.9		0.1
	10,000 - 99,999		1
m: METERS	SINGLE RANGE	ACCURACY	RESOLUTION
m/M (meters/min.)	0.11 - 999.99	± 0.06	0.01
	1,000.0 - 3,810.0	± 0.3	0.1
m (length)	0.02 - 999.99		0.01
	1,000.0 - 9,999.9		0.1
	10,000 - 99,999		1

NOTE: When using the 6" master wheel, accuracy can be affected as much as 0.3% of reading



Although the tachometer alone is able to achieve the above ranges, the 6" master wheel has maximum speed limitation of 5,000 FPM (for safety reasons)

TROUBLESHOOTING

The following are general checkpoints; please call your local Shimpo representative or contact Shimpo Instruments directly for further assistance.

No laser beam is evident:

- Confirm that power switch is functioning
- Confirm that batteries are functioning and that polarity is correct

Inaccurate measurement results:

- If the surface being measured is highly reflective, it may need to be painted a darker color in order to ensure reliable results
- Beam may not be hitting the reflective tape, or taped area may be too small
- Measuring distance may be too short (unit must be at least 5" from intended mark)

DIMENSIONS AND SPECIFICATIONS

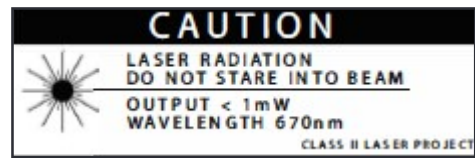
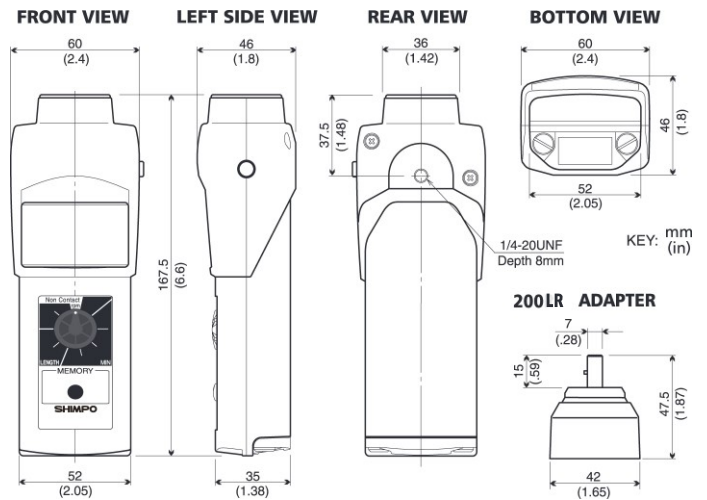

6" Circumference Wheel

