



Next Day Shipping
On Many Configurations

A Series

- ▶ MOPD: 1000 PSI (69 Bar)
- ▶ C_v Range: 0.019 to 0.3 (K_v Range: 0.016 to 0.256)
- ▶ 6 Watts

The A Series gives you a highly adaptable design for practically all applications requiring flow between C_v 0.019 and 0.300 (K_v 0.016 to 0.259). This robust 2- or 3-way miniature solenoid utilizes a stainless steel body to resist corrosion for most acids, alkaline solutions, and harsh environments. Also available in plastic—from polypropylene to Delrin®—when specific inert or demanding requirements are needed. Available in numerous port configurations, orifice sizes, and material combinations, the A Series is a highly flexible valve that fulfills the requirements for most applications.

Typical Applications

Stainless Steel Bodies:

- Medical Equipment
- Laboratory Equipment
- Food Processing Equipment

Brass Bodies:

- Industrial Applications
- Automotive
- Water Transfer Systems



CE

Dimensions

Threaded Port Body

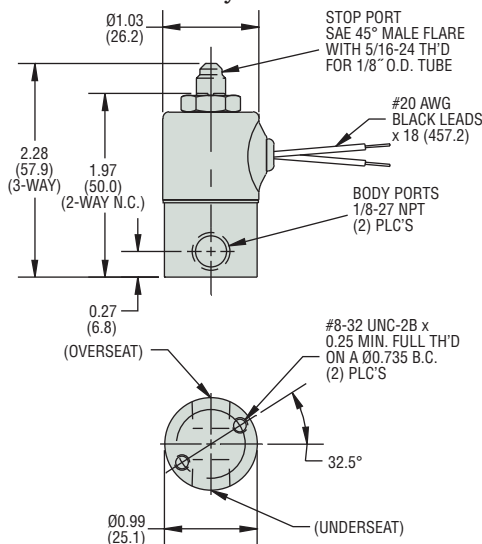

Manifold Mount Body

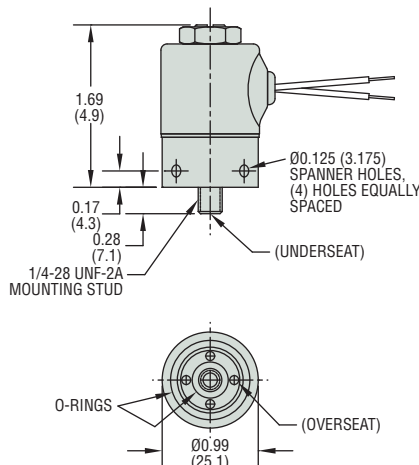

Molded Coil

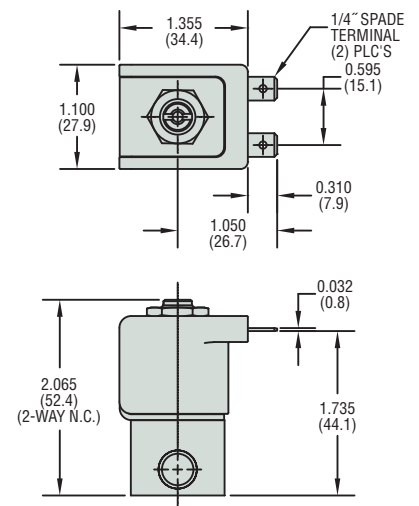

How To Order

Use the **Bold** characters from the choices listed on the following page to construct a product code.

A2213 - 3 - BB - N - NO - LB - 110/60VAC - WM-TP

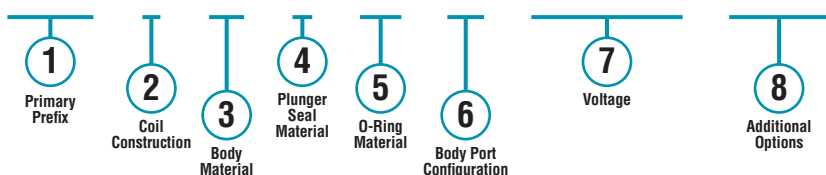

Note: After the Primary Prefix, any "-Code" may be blank when standard (blank) selections are specified.

Example:

A2213-3-BB-N-NO-LB-110/60VAC-WM-TP

2-Way N.O. (with 1/8"-27 NPT stop port adaptor) solenoid valve, with brass body, neoprene plunger seal, neoprene O-ring, 1/4"-18 FNPT body ports, operating at 110/60 VAC/Hz, and includes the mounting bracket and PTFE coated plunger options.

Alternate 1/2" Conduit Housing

Available on all body configurations

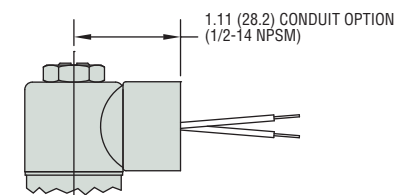

Stop Port

Standard on 2-way N.O.;
Option "AD" on 3-Way.

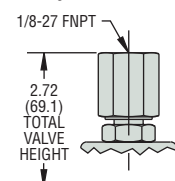





Take advantage of next day shipping by making your selections from those marked with the Lightning Bolt icon.

Part Prefix Table ①

	Orifice				MOPD		C _v		K _v		① Primary Prefix	
	Body		Stop		psig	bar	Body	Stop	Body	Stop	Grommet Housing	Conduit Housing
	inches	mm	inches	mm								
2-WAY N.C.	1/32	0.79	—	—	1000	69	0.020	—	0.017	—	A2011 ⚡	A2021
	3/64	1.19	—	—	500	34	0.035	—	0.030	—	A2012 ⚡	A2022
	1/16	1.59	—	—	300	21	0.065	—	0.055	—	A2013 ⚡	A2023
	5/64	1.98	—	—	200	14	0.090	—	0.077	—	A2014 ⚡	A2024
	3/32	2.38	—	—	175	12	0.155	—	0.132	—	A2015 ⚡	A2025
	1/8	3.18	—	—	100	6.9	0.240	—	0.205	—	A2016 ⚡	A2026
	5/32	3.97	—	—	50	3.4	0.300	—	0.256	—	A2017 ⚡	A2027
2-WAY N.O. (option AD standard)	—	—	1/32	0.79	200	14	—	0.019	—	0.016	A2211 ⚡	A2221
	—	—	3/64	1.19	150	10	—	0.040	—	0.034	A2212 ⚡	A2222
	—	—	1/16	1.59	100	6.9	—	0.075	—	0.064	A2213 ⚡	A2223
3-WAY N.C. Free Vent	1/32	0.79	1/32	0.79	200	14	0.019	0.019	0.016	0.016	A3011 ⚡	A3021
	3/64	1.19	3/64	1.19	150	10	0.040	0.040	0.034	0.034	A3012 ⚡	A3022
	1/16	1.59	3/64	1.19	100	6.9	0.070	0.040	0.060	0.034	A3013 ⚡	A3023
	1/16	1.59	1/16	1.59	75	5.2	0.070	0.070	0.060	0.060	A3014 ⚡	A3024
	3/32	2.38	3/64	1.19	50	3.4	0.170	0.040	0.145	0.034	A3015 ⚡	A3025
3-WAY N.C. Line Connection	1/32	0.79	1/32	0.79	200	14	0.019	0.019	0.016	0.016	A3111 ⚡	A3121
	3/64	1.19	3/64	1.19	150	10	0.040	0.040	0.034	0.034	A3112 ⚡	A3122
	1/16	1.59	3/64	1.19	100	6.9	0.070	0.040	0.060	0.034	A3113 ⚡	A3123
	1/16	1.59	1/16	1.59	75	5.2	0.070	0.070	0.060	0.060	A3114 ⚡	A3124
	3/32	2.38	3/64	1.19	50	3.4	0.170	0.040	0.145	0.034	A3115 ⚡	A3125
3-WAY N.O.	1/32	0.79	1/32	0.79	150	10	0.019	0.019	0.016	0.016	A3211 ⚡	A3221
	3/64	1.19	3/64	1.19	100	6.9	0.040	0.040	0.034	0.034	A3212 ⚡	A3222
	1/16	1.59	3/64	1.19	90	6.2	0.070	0.040	0.060	0.034	A3213 ⚡	A3223
	1/16	1.59	1/16	1.59	75	5.2	0.070	0.070	0.060	0.060	A3214 ⚡	A3224
	3/32	2.38	3/64	1.19	50	3.4	0.170	0.040	0.145	0.034	A3215 ⚡	A3225
3-WAY Multi Purpose	1/32	0.79	1/32	0.79	125	8.6	0.019	0.019	0.016	0.016	A3311 ⚡	A3321
	3/64	1.19	3/64	1.19	100	6.9	0.040	0.040	0.034	0.034	A3312 ⚡	A3322
	1/16	1.59	3/64	1.19	90	6.2	0.070	0.040	0.060	0.034	A3313 ⚡	A3323
	1/16	1.59	1/16	1.59	75	5.2	0.070	0.070	0.060	0.060	A3314 ⚡	A3324
	3/32	2.38	3/64	1.19	25	1.7	0.170	0.040	0.145	0.034	A3315 ⚡	A3325
3-WAY Directional Control	1/32	0.79	1/32	0.79	225	16	0.019	0.019	0.016	0.016	A3411 ⚡	A3421
	3/64	1.19	3/64	1.19	150	10	0.040	0.040	0.034	0.034	A3412 ⚡	A3422
	1/16	1.59	3/64	1.19	100	6.9	0.070	0.040	0.060	0.034	A3413 ⚡	A3423
	1/16	1.59	1/16	1.59	75	5.2	0.070	0.070	0.060	0.060	A3414 ⚡	A3424
	3/32	2.38	3/64	1.19	50	3.4	0.155	0.040	0.132	0.034	A3415 ⚡	A3425







2 Coil Construction

- (blank)** = Tape-wrapped, Class B, with 18" (45.7cm) lead wires* 
- W** ___ = Tape-wrapped coil, lead wires, non-standard length (specify length)
- 1** = Encapsulated coil, Class B, lead wires
- 2M** = Over molded coil, Class F, lead wires
- 3** = Encapsulated coil, Class H, lead wires
- 3M** = Over molded coil, Class H, lead wires
- 4** = Encapsulated coil, Class B, 3/16" (4.76mm) spade terminals
- 5M** = Over molded coil, Class F, 1/4" (6.35mm) spade terminals
- 6M** = Over molded coil, Class H, 1/4" (6.35mm) spade terminals
- 10** = Externally rectified coil, AC Voltages (lead wires only) 
- 11** = Tape-wrapped coil, Class H, lead wires
- HC2** = Encapsulated coil, Class B, EN175301-803 Form C DIN, Industrial, 9.4mm, 2+1 poles







3 Body Material

- (blank)** = 303 Stainless Steel* 
- BB** = Brass
- SB** = 304 Stainless Steel
- SB5** = 316 Stainless Steel
- SBF** = 430F Stainless Steel

4 Plunger Seal Material

- (blank)** = Nitrile* 
- E** = EPR 
- GV** = Gasoline Viton® (2-way N.C. valves only)
- N** = Neoprene 
- NS** = Nitrile (NSF/FDA, 2-way N.C. valves only) 
- PF** = Perfluoroelastomer 
- R** = Rulon® (2-way N.C. valves only)
- T** = PTFE
- V** = Viton® 





5 O-Ring Material

- (blank)** = Nitrile* 
- EO** = EPR 
- NO** = Neoprene 
- NSO** = Nitrile (NSF/FDA, 2-way N.C. valves only) 
- PFO** = Perfluoroelastomer 
- TO** = PTFE
- VO** = Viton® 

6 Body Port Configuration

- (blank)** = 1/8-27 NPT female thread* 
- LB** = 1/4-18 NPT female thread
- BD** = #10-32 female straight thread
 - max. orifice = 1/8" (3.18mm)
- LT** = 1/8-28 BSPT female thread (2-way N.C. valves only)
- LU** = 1/4-19 BSPT female thread (2-way N.C. valves only)
- MM** = Manifold mount (1/4-28 UNF-2A mounting stud)^{†††}
- MM3** = Manifold mount (5/16-24 UNF-2A mounting stud)^{†††}
- OB** = Omit body (operator style)
- MB** = Bottom metering - max. orifice = 3/32" (2.38mm)
- BI** = Bottom over-seat port, female thread
 - max. orifice = 1/8" (3.18mm)
- BIM** = Bottom over-seat port, 1/8-27 NPT male thread
 - max orifice = 5/64" (1.98mm) brass body only
- BO** = Bottom under-seat port, female thread
- BOM** = Bottom under-seat port, 1/8-27 NPT male thread
 - max orifice = 1/8" (3.18mm) brass body only
- RL** = 90° porting - left hand
- RR** = 90° porting - right hand
- BS** = Stop port, #10-32 female straight thread[†]

7 Voltage^{††} (see note below)

- C203** = 12 VDC 
- C204** = 24 VDC 
- C301** = 120/50/60R (add Coil Option -10) 
- C303** = 240/50/60R (add Coil Option -10) 
- ___ **VDC** = DC (specify DC voltage)
- ___ **VAC** = AC (specify AC voltage; includes copper shading ring)

8 Additional Options

- Y** = Yoke
- WM** = Mounting bracket
- TP** = PTFE coated plunger
- AD** = 1/8 - 27 NPT stop port adapter (3-way valves only) 
- QQ** = Quiet operation (2-way valves only)
- S** = Silver shading ring
- OC** = Cleaned for oxygen use
- VAC** = Vacuum application - 0 to 29.5" Hg (0 to 1000mBar)
- G1** = One-piece 303 Stainless Steel guide assembly
- G5** = One piece 316 Stainless Steel guide assembly

* Standard selection; will be used unless otherwise specified. Standard selections are not referenced in final part number.

[†] Plastic body available, contact Gems.
^{††} Can be AC rectified without shading ring. Use coil construction Code 10.
^{†††} Teflon® o-ring not suitable for manifold mount.



Take advantage of next day shipping by making your selections from those marked with the Lightning Bolt icon.

Gems specializes in the design and manufacturing of custom solenoid valves and fluidic systems. If you don't see what you're looking for, or have a question, contact us at 800-378-1600 or info@gemssensors.com.