

Flow Set Point Switching – RFS Types

- ▶ Combines visual confirmation of flow with dynamic, electronic switch operation
- ▶ Easy, adjustable switch point calibration: a local LED signals when set point is reached

RotorFlow® Switches build an extra level of reliability and protection into your equipment. By principle of operation, the rotor cannot be deceived into indicating a positive flow situation when no flow actually exists. Once set to a desired actuation point, RotorFlow will switch to a “no-flow” condition should the rotor stop for any reason.

Typical Applications

Protect expensive electronic equipment from coolant flow failure on...

- Semiconductor Processing Equipment
- Lasers • Medical Equipment
- X-Ray and Other High Power Tubes
- Robotic Welding Equipment



File No. E45168



Specifications

Wetted Materials	Brass, 316 Stainless Steel or Polypropylene (Hydrolytically Stable, Glass Reinforced)	
Body		
Rotor Pin	Ceramic	
Rotor	PPS Composite, Black	
Lens	Polysulfone	
O-Ring	Viton® (Alloy Bodies); Buna N (Polypropylene Body)	
Low Flow Adaptor	Glass Reinforced Polypropylene	
Operating Pressure, Maximum	200 PSIG (13.8 bar) @ 70°F (21°C), 100 PSIG (6.9 bar) Max. @ 212°F (100°C) ¹	
Brass or Stainless Steel Body		
Polypropylene Body	100 PSIG (6.9 bar) @ 70°F (21°C), 40 PSI (2.8 bar) Max. @ 180°F (82°C)	
Operating Temperature,	-20°F to 212°F (-29°C to 100°C)	
Brass or Stainless Steel Body		
Polypropylene Body	-20°F to 180°F (-29°C to 82°C)	
Electronics	150°F (65°C) Ambient	
Viscosity, Maximum	200 SSU	
Input Power	24 VDC or 115 VAC	
Relay Contact Ratings (SPDT)	1 Amp, 24 VDC Resistive; 0.3 Amp, 110 VAC	
Current Consumption	No Load	Load (Relay Energized)
24 VDC	20mA	35mA
115 VAC	45mA	95mA
Repeatability	2% Maximum Deviation	
Set Point Accuracy (Factory Set)	± 5%	
Set Point Differential	15% Maximum	
Electrical Termination	20 AWG PVC-Jacketed, 24" Cable. Color Codes: Red = +VAC/VDC, Black = Ground, White = N.O. Contact, Brown = N.C. Contact, Green = Common	

Note:
1. Optional pulsed output available with RFS. Consult factory.

Dimensions

Polypropylene Bodies

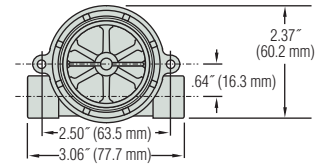

VDC

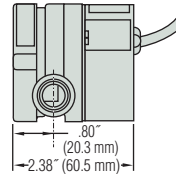

VAC

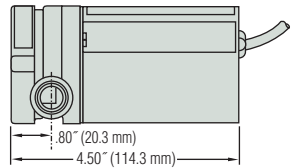

Brass and Stainless Steel Bodies - .25" and .50" Port

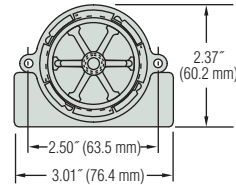

VDC

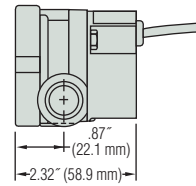

VAC

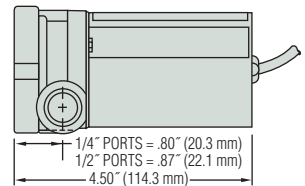

Brass and Stainless Steel Bodies - .75" and 1.00" Port

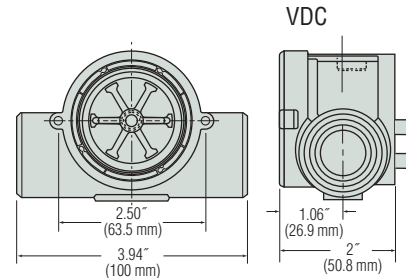

VDC

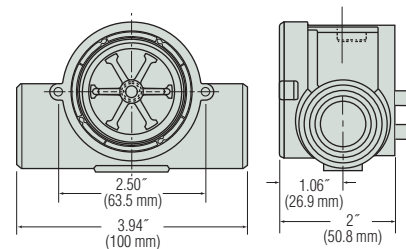

VAC

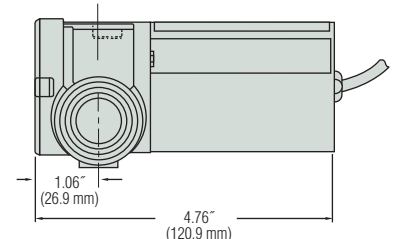

FLOW SENSORS – ELECTRONIC

Switch Set Point Calibration With LED Signal (RFS Type)

With the unit installed in the line and power supplied, complete the following steps to calibrate switch actuation point with proper flow rate. A small flat-blade screwdriver is the only tool required.

1. Adjust liquid flow in the line to the rate at which switch actuation is desired.
2. Insert screwdriver into opening on backside of housing and fit blade into the potentiometer adjustment screw inside.
3. If LED is not illuminated, slowly turn screwdriver counterclockwise and stop as soon as LED illuminates.
4. If LED is illuminated, turn screwdriver clockwise until LED light goes out. Then, slowly turn screwdriver counterclockwise and stop as soon as LED illuminates.

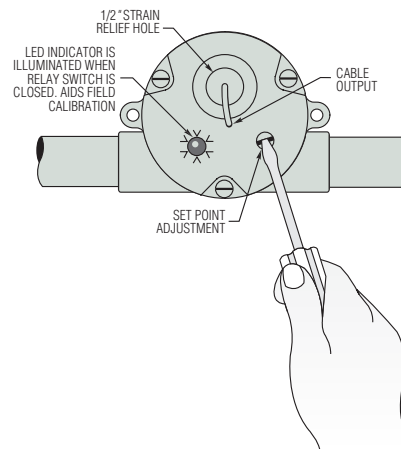

How To Order

Specify Part Number based on desired body material, port size and input power rating.

Body Material	Port Size NPT	Flow Ranges – GPM		Input Power	Part Number
		Low Range*	Standard Range		
Polypropylene	.25"	0.1 to 1.0	0.5 to 5.0	24 VDC	155425 ⚡
				115 VAC	155876 ⚡
	.50"	1.5 to 12.0	4.0 to 20.0	24 VDC	155485 ⚡
				115 VAC	155886 ⚡
Brass	.25"	0.1 to 1.0	0.5 to 5.0	24 VDC	156265 ⚡
				115 VAC	156266 ⚡
	.50"	1.5 to 12.0	4.0 to 20.0	24 VDC	156268 ⚡
				115 VAC	156269 ⚡
	.75"	–	5.0 to 30.0	24 VDC	180395 ⚡
				115 VAC	180396 ⚡
	1.00"	–	8.0 to 60.0	24 VDC	181688 ⚡
				115 VAC	181689 ⚡
Stainless Steel	9/16-18**	0.1 to 1.0	0.5 to 5.0	24 VDC	165073 ⚡
				115 VAC	165074 ⚡
	.50"	1.5 to 12.0	4.0 to 20.0	24 VDC	165077 ⚡
				115 VAC	165078 ⚡
	.75"	–	5.0 to 30.0	24 VDC	181691 ⚡
				115 VAC	181692 ⚡
	1.00"	–	8.0 to 60.0	24 VDC	181693 ⚡
				115 VAC	181694 ⚡

* With use of Low Flow Adapter supplied. See Page F-8 for more information.
 ** Straight thread with O-ring seal.

⚡ – Stock Items.

Special Requirements:

GEMS caters to OEM needs with special configurations for potable water and enhanced chemical capabilities. Consult factory for further details.

For higher pressure/temperature ratings, stainless face plates are available. Consult factory.

High Resolution Black Rotor
 PPS composite. Each of the six rotor arms is magnetized. A PTFE loaded bushing ensures long life.



Pressure Drop-Typical

