

**Thermo Scientific AquaSensors™
AV88 Universal Analyzer
and Controller
User Guide**



ROSS and the COIL trade dress are trademarks of Thermo Fisher Scientific Inc. U.S. patent 6,793,787.

AQUAfast, Cahn, ionplus, KNipHE, No Cal, ORION, perpHect, PerpHecT, PerpHecTion, pHISA, pHuture, Pure Water, Sage, Sensing the Future, SensorLink, ROSS, ROSS Ultra, Sure-Flow, Titrator PLUS and TURBO2 are registered trademarks of Thermo Fisher.

1-888-pHAX-ION, A+, All in One, Aplus, AQUAsnap, AssuredAccuracy, AUTO-BAR, AUTO-CAL, AUTO DISPENSER, Auto-ID, AUTO-LOG, AUTO-READ, AUTO-STIR, Auto-Test, BOD AutoEZ, Cable-Free, CERTI-CAL, CISA, DataCOLLECT, DataPLUS, digital LogR, DirectCal, DuraProbe, Environmental Product Authority, Extra Easy/Extra Value, FAST QC, GAP, GLPcal, GLPcheck, GLPdoc, ISEasy, KAP, LabConnect, LogR, Low Maintenance Triode, Minimum Stir Requirement, MSR, NISS, One-Touch, One-Touch Calibration, One-Touch Measurement, Optimum Results, Orion Star, Pentrode, pHuture MMS, pHuture Pentrode, pHuture Quatrode, pHuture Triode, Quatrode, QuiKcheK, rf link, ROSS Resolution, SAOB, SMART AVERAGING, Smart CheK, SMART STABILITY, Stacked, Star Navigator 21, Stat Face, The Enhanced Lab, ThermaSense, Triode, TRIUMpH, Unbreakable pH, Universal Access are trademarks of Thermo Fisher.

© 2009 Thermo Fisher Scientific Inc. All rights reserved. All trademarks are the property of Thermo Fisher Scientific Inc. and its subsidiaries.

The specifications, descriptions, drawings, ordering information and part numbers within this document are subject to change without notice.

This publication supersedes all previous publications on this subject.

Preface

This instruction manual serves to explain the use of the Thermo Scientific AquaSensors AV88 Universal Analyzer and is written to cover as many applications as possible. Please do not hesitate to contact Thermo Fisher Scientific or an authorized representative with questions or concerns.

The information presented in this instruction manual is subject to change without notice as improvements are made, and does not represent any commitment whatsoever on the part of Thermo Fisher Scientific.

Thermo Fisher Scientific cannot accept any responsibility for damage or malfunction of the product due to improper use.

Contact Information

To contact Thermo Scientific AquaSensors Technical Support:

Within the United States call 1.800.225.1480 or fax 978-232-6015.

Outside the United States call 978.232.6000 or fax 978.232.6031.

In Europe, the Middle East and Africa, contact your local authorized dealer.

Visit us on the web at www.thermo.com/processwater

Safety Information



The Thermo Scientific AquaSensors AV88 Universal Analyser shall be installed and operated only in the manner specified. Only a skilled, trained or authorized person should carry out installation, setup and operation of the sensor system.

Before using the display, make sure that the sensor cable is connected as specified. Failure to do so may result in permanent damage to the system of its components.

Protection against electric shock will be achieved only by observance of the corresponding installation rules.

TABLE OF CONTENTS

1.	INTRODUCTION	4
1.1.	GENERAL INFORMATION	4
1.2.	INTENDED USE	5
2.	PRODUCT DESCRIPTION	6
2.1.	SYSTEM OVERVIEW	6
2.2.	MOUNTING	6
2.3.	POWER, RELAY AND CURRENT LOOP WIRING	10
2.4.	PERSONALITY MODULE INSERTION AND REMOVAL	11
2.5.	SENSOR PARAMETER WIRING	12
2.6.	HOST COMMUNICATIONS WIRING	13
2.7.	MEASURE SCREEN OVERVIEW	13
3.	MENU STRUCTURE AND NAVIGATION	15
4.	CALIBRATE MENUS	19
4.1.	2-POINT BUFFER CALIBRATION (SENSOR TYPE: PH)	21
4.2.	ABORTED CALIBRATION (SENSOR TYPE: ALL)	24
4.3.	1-POINT SAMPLE CALIBRATION (SENSOR TYPE: ALL)	25
4.4.	ZERO CALIBRATE MENU (SENSOR TYPE: CONDUCTIVITY, DO, TURBIDITY)	28
4.5.	AIR CALIBRATION (SENSOR TYPE: D.O.)	30
4.6.	TEMPERATURE 1-POINT SAMPLE CALIBRATION	32
5.	CONFIGURE MENU	35
5.1.	MAIN CONFIGURE MENUS	36
5.2.	NAVIGATING SENSOR FILTER CONFIGURATION	37
5.3.	NAVIGATING THE USER-ENTERED CONCENTRATION TABLE SCREENS	40
6.	HOST COMMUNICATIONS	46
7.	ANALOG OUTPUT MENUS	46
7.1.	ASSIGNING 4 mA AND 20 mA PARAMETER VALUES	47
7.2.	CALIBRATING OUTPUT CURRENT	48
8.	PID CONTROLLER	50
9.	RELAY MENUS	52
10.	HELP MENU	54
11.	LIMITED WARRANTY	55
12.	TERMS AND CONDITIONS	56

TABLE OF TABLES

Table 1:	A typical concentration table with four points	40
Table 2:	Record the table values here before entering them	41
Table 3:	Summary of key actions.	44
Table 4:	The default concentration table	45

1. INTRODUCTION

1.1. General Information

Thank you for purchasing the Thermo Scientific AquaSensors AV88 Universal Analyzer.

The product is designed for continuous use in industrial process applications and complies with safety regulations currently in force. Improper use could lead to hazards for the user or a third-party, and/or adverse effects to the plant or other equipment.

Thermo Fisher Scientific does not accept any liability for damage that may arise if information in this manual is not followed. Therefore, the operating instructions and specifications must be read and understood by all persons involved in installation and operation of this equipment.

This manual identifies safety instructions and additional information by means of the following symbols:



This symbol draws attention to **safety instructions and warnings of potential danger**, which if neglected, could result in injury to persons and/or damage to property.



This symbol identifies **additional information and instructions**, which if neglected, could lead to inefficient operation and possible loss of production.

It is recommended that this manual be made accessible to everyone who may need it as a reference.

Please contact Thermo Fisher Scientific or an authorized representative with any questions.

1.2. Intended use

The Thermo Scientific AquaSensors AV88 Universal Analyzer is used to monitor, configure, calibrate and diagnose all AnalogPlus sensor parameters. AnalogPlus sensors must be ordered specifically for the AV88. Thermo Fisher Scientific also carries AnalogPlus replacement sensors that connect to competitors' analyzers.

Data is reported through two scalable 4-20 milliamp current outputs or through one of several digital protocols. Options include outputs configured for PID and up to 2 relays.

Any other use, or use not mentioned here, that is incompatible with the technical specifications is deemed inappropriate. The operator is solely responsible for any damage arising from such use.

Other prerequisites for appropriate use include:

- Observing the instructions, notes and requirements set out in this instruction manual.
- Observing all local safety regulations.
- Observing all warnings and cautions in the documentation regarding all products used in this measurement system, including the sensor, mounting hardware, AV88 electronics and cabling.
- Observing the prescribed environmental and operational conditions.
- Observing chemical compatibility with all wetted materials.

1.3. Safety Instructions

The AV88 Universal Analyzer should be installed and operated only by personnel familiar with the sensor and qualified for such work.



A defective AV88 should be returned to Thermo Fisher Scientific for repair or replacement. Contact Thermo Fisher Scientific to obtain a Return Material Authorization (RMA) number.

No modifications to the AV88s are allowed. The manufacturer/supplier accepts no responsibility for damage caused by unauthorized modifications. The risk is borne entirely by the user.

1.4. Removal from Service / Correct Disposal of the AV88 Universal Analyzer

Removal from Service

- Disconnect the cable wiring from the analyzer terminal block.
- Remove the AV88 from the mounting hardware.

Correct Disposal of Unit

- When the AV88 is taken out of service, observe the local environmental regulations for correct disposal.

2. PRODUCT DESCRIPTION

2.1. System Overview

The AV88 is a universal analyzer for use with all AV88 enabled AnalogPlus sensors. The enclosure has ¼-DIN dimensions for easy mounting and is rated NEMA 4X for outdoor use. It uses a liquid crystal display (LCD) with a high contrast backlight for best readability and is powered with 24 volts DC.



The AV88 is quickly configured for a specific sensor type with a small plug-in personality module adjacent to the sensor terminal blocks. This module provides wiring information about specific sensor connections and provides the appropriate calibration, configuration and diagnostic menus. When there is no plug-in personality module configured inside the AV88, the measure screen will show dashed lines.

The AV88 has two standard 4-20 current loops. Options include two alarm/control relays and network communications to a host computer.

Host communication options include, Modbus, DeviceNet, RS-232 ASCII, Profibus and others.

There are seven keys for menu navigation. The MENU key provides options for calibration, configuration, communications, outputs and relays. The ESC key is used to return to the measure screen.

2.2. Mounting

The AV88 can be mounted on a wall or panel mounted in ¼-DIN or ½-DIN forms. A gasket is built into the display for a NEMA 4X seal. Mounting instructions must be followed to maintain seals. The AV88 can be pipe mounted and panel mounted with optional mounting hardware.

2.2.1. Conduit Box Wall Mount

The AV88 conduit box is mounted to a wall or plate with #8 or M4 screws through the mounting holes as shown. There are seven Pg11 and Pg16 knockouts in the conduit box. Two cord grips are supplied and it is recommended that they be used in the conduit holes on the bottom side of the box to prevent rain or moisture from settling at the conduit interface. It is also possible to mount the box using interior breakouts. Four plastic caps are provided to seal the interior mounting screws. Nema 4X ratings will be maintained only when the #8 mounting screws are used in the holes outside the conduit box gasket.

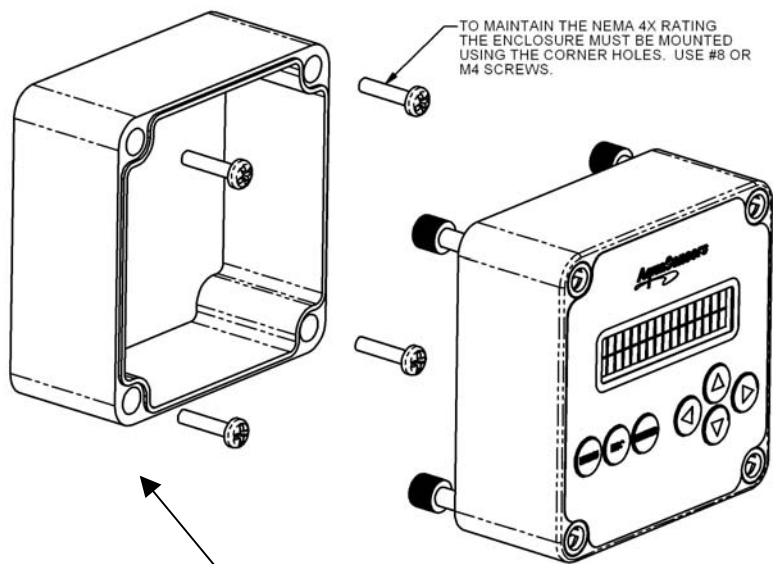

AV88 conduit box is mounted to a wall or plate with #8 or M4 screws through the mounting holes as shown.

Seven Pg11/16 Conduit breakouts are available for cord grips or conduit hardware.



2.2.2. 1/2-DIN Panel Mount

A 1/2-DIN panel mount bezel and gasket can be ordered to fit the AV88 as shown. The AV88 display is tightened down to the bezel using the four captured screws in the AV88. The bezel is then mounted to a 1/2-DIN square opening with the hardware shown in the figure below.

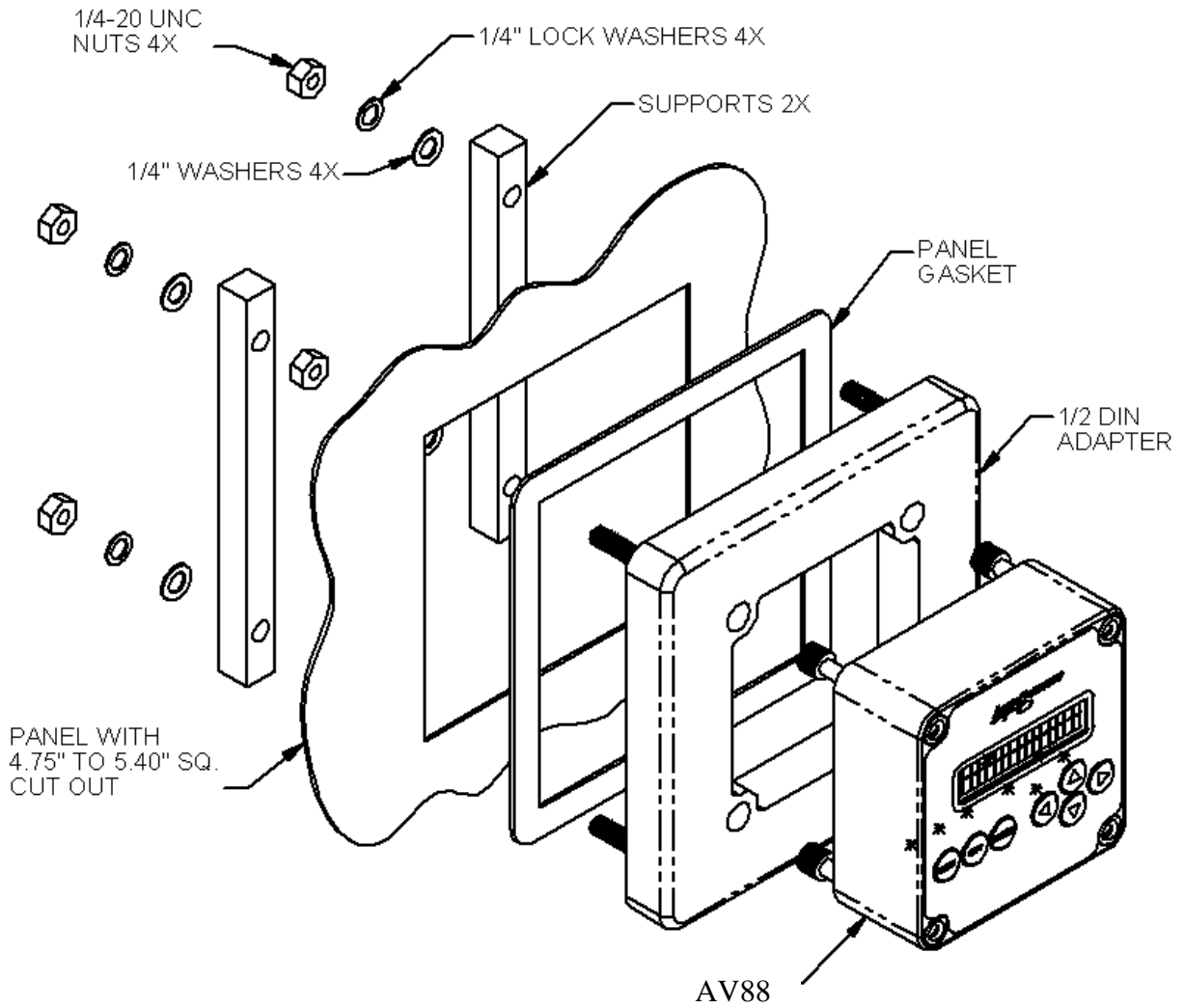

2.2.3. 1/4-DIN Panel Mount

The AV88 Display can be mounted directly to a 1/4-DIN panel opening using the captive mounting screws in the AV88 and the 1/4-DIN supports as illustrated in the figure below. A 1/4-DIN bezel gasket can be provided to ensure a NEMA 4X seal on the panel.

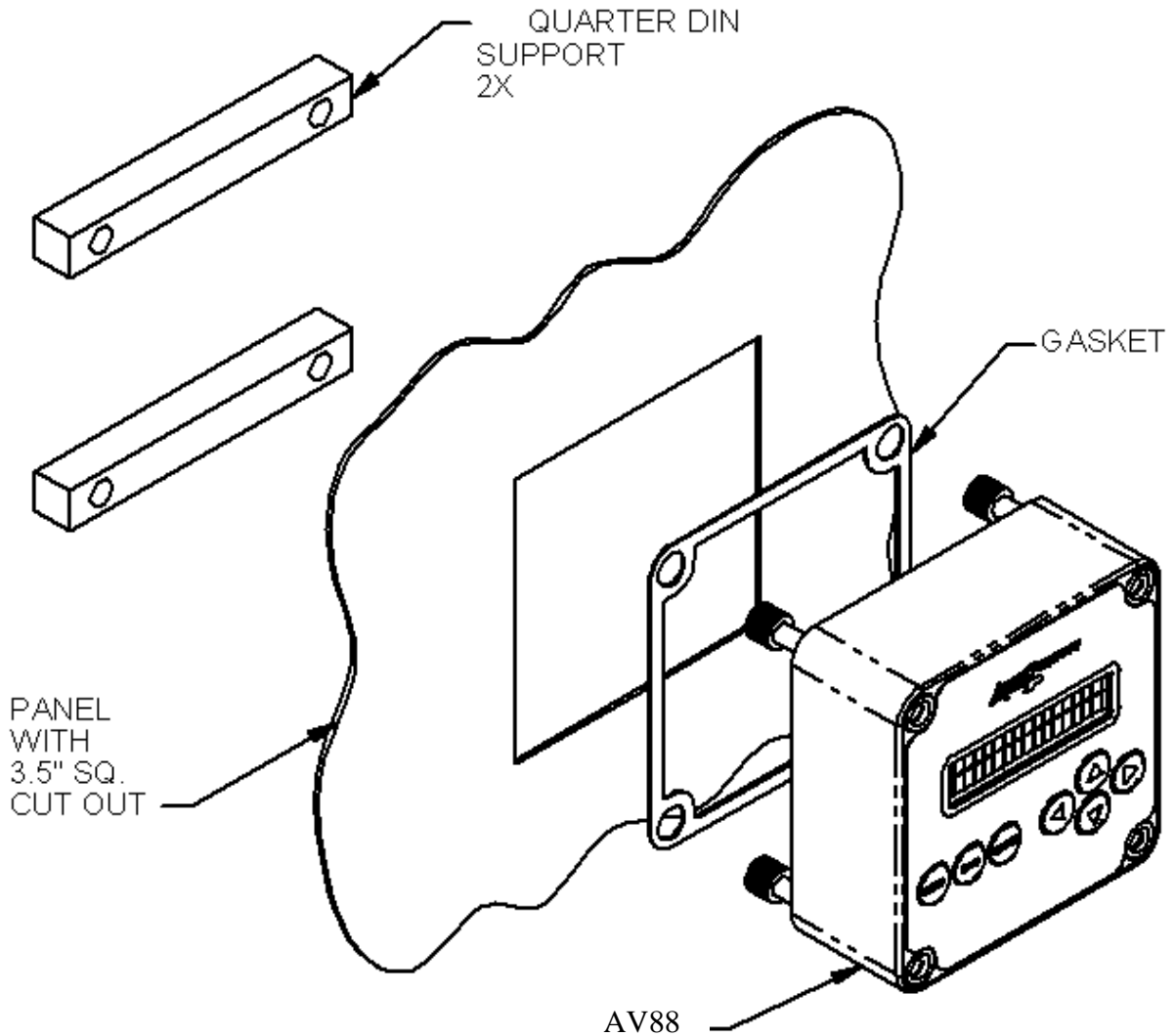

2.3. Power, Relay and Current Loop Wiring

The AV88 Display comes with two terminal blocks. The 10-pin block on the left is used to hook up two current loops and two relays (if installed). The 12-pin terminal block on the right is used to hook up 24-volt power, host communications (if installed) and one of many analytical sensors. There is a sensor personality module for each sensor type that is plugged in and fastened down as shown in figure 2.1A.

Figure 2.1A: AV88 wiring when configured for Differential pH

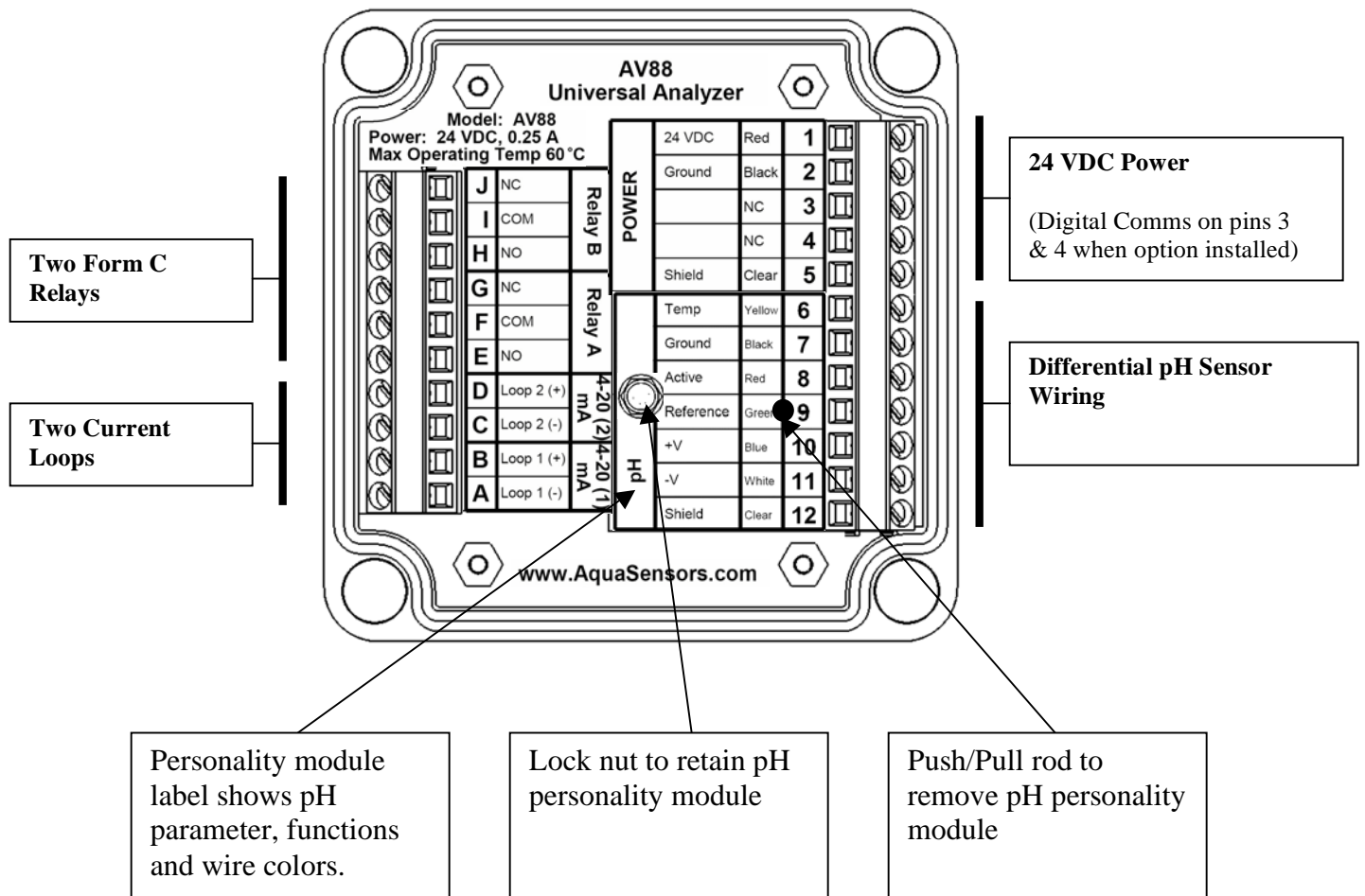

Sensor personality modules show which sensor the AV88 is configured for and provide wiring information.

2.4. Personality Module Insertion and Removal

The AV88 can be configured to work with any AnalogPlus sensor parameter by installing the desired personality module.

Removal

To remove a personality module, disconnect the sensor cable from the screw terminals, remove the acorn nut from the center of the box and then pull on the push/pull rod as shown in Figure 2.1B. Be sure to keep the acorn nut in a safe place so that a new module can be properly secured.

Figure 2.1B: AV88 with personality module removed

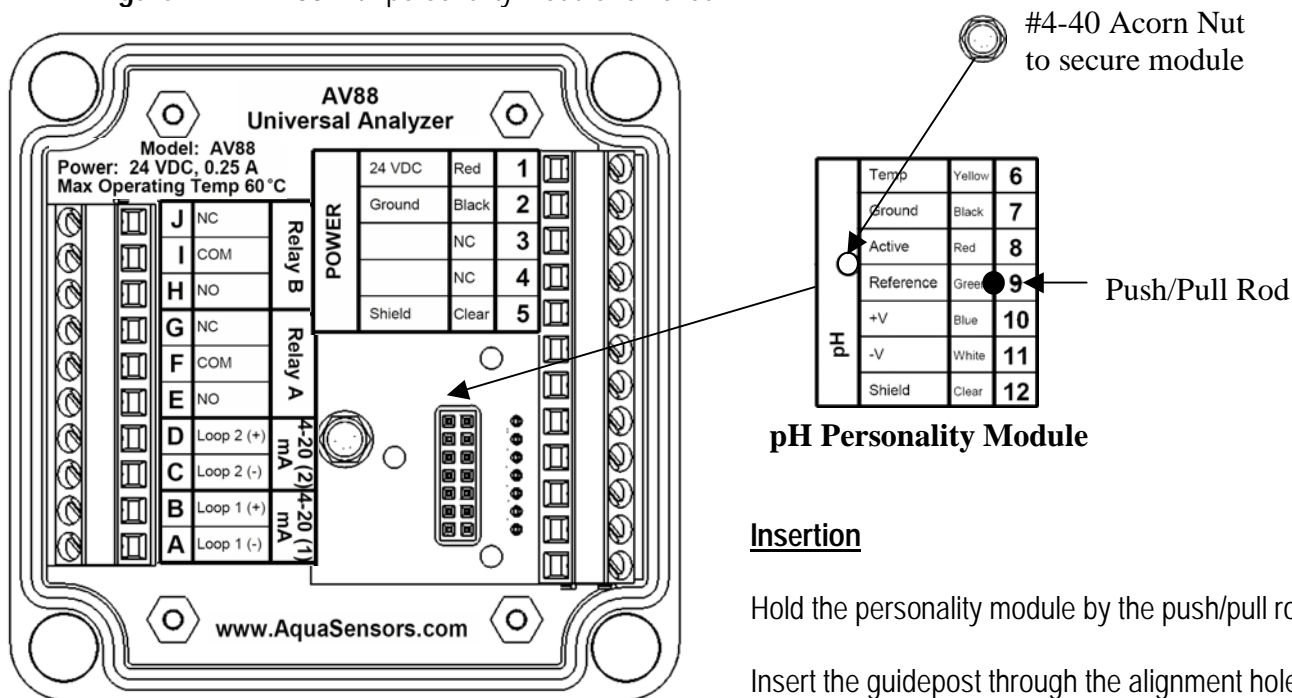

Insertion

Hold the personality module by the push/pull rod.

Insert the guidepost through the alignment hole.

Gently insert the module. Do not force the connector pins in place.

When the personality module is seated, secure it by installing the #4-40 Acorn Nut.

The full family of parameter specific personality modules and associated wiring information is shown in Figure 2.1C.

2.5. Sensor Parameter Wiring

The AV88 can be configured to work with any AnalogPlus sensor by installing the appropriate personality module. Each module clearly shows how to wire the sensor with terminal numbers, wire colors and sensor functions.

Current parameters include: pH, ORP, Contacting Conductivity, Resistivity, Dissolved Oxygen, Dissolved Ozone, Toroidal Conductivity and Turbidity.

pH	Temp	Yellow	6
	Ground	Black	7
	Active	Red	8
	Reference	Green	9
	+V	Blue	10
	-V	White	11
	Shield	Clear	12
	Contacting Conductivity	Temp	White
Ground		Blue	7
Sense		Black	8
Drive		Red	9
		NC	10
		NC	11
Shield		Clear	12
Ozone		Temp	Yellow
	Ground	Black	7
	Sense	Red	8
	Drive 1	Green	9
	+V	Blue	10
	-V	White	11
	Shield	Clear	12
	Toroidal Conductivity	Temp	Red
Ground		Yellow	7
Sense		Green	8
Drive 1		White	9
Drive 2		Blue	10
		NC	11
Shield		Clear	12
ORP		Temp	Yellow
	Ground	Black	7
	Active	Red	8
	Reference	Green	9
	+V	Blue	10
	-V	White	11
	Shield	Clear	12
	Resistivity	Temp	White
Ground		Blue	7
Sense		Black	8
Drive		Red	9
		NC	10
		NC	11
Shield		Clear	12
Dissolved Oxygen		Temp	Yellow
	Ground	Black	7
	Sense	Red	8
	Drive 1	Green	9
	+V	Blue	10
	-V	White	11
	Shield	Clear	12
	Turbidity	Temp	Yellow
Ground		Black	7
Sense		Red	8
Gain		Green	9
+V		Blue	10
-V		White	11
Shield		Clear	12

Figure 2.1C: AV88 personality module family

2.6. Host Communications Wiring

The AV88 can be ordered with or without digital communications to a host computer. Labeling for host communications on screw terminals 3 and 4 indicates the type of communications provided.

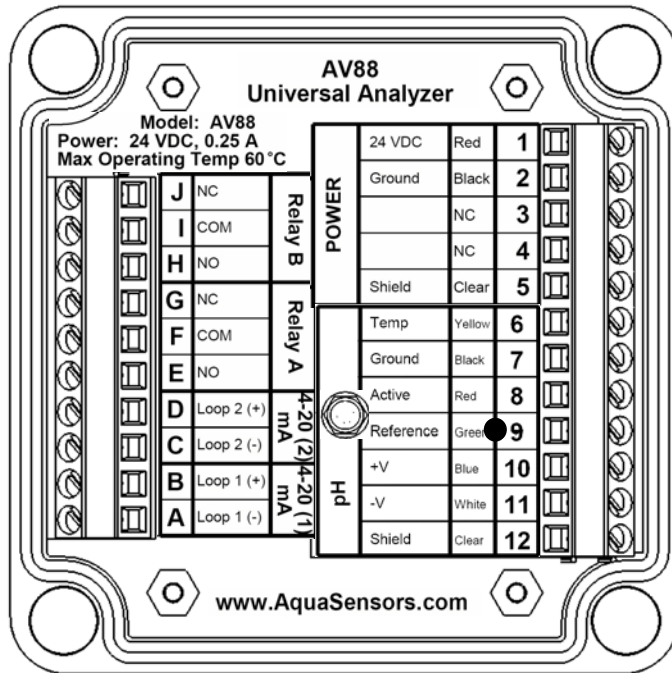

Digital Communications - Terminals 3 and 4.

	DeviceNet	Modbus	RS-232
Terminal 3	CAN_H	Comms(-)	Tx
Terminal 4	CAN_L	Comms(+)	Rx

When no host communications option is installed the label will show "NC" by each terminal.

Figure 2.1D: AV88 Host Communications Wiring

2.7. Measure Screen Overview

The AV88 user interface is shown in Figure 2.2. It consists of an LCD module that contains two lines of 16 alphanumeric characters and seven keys to navigate the menu. The contrast of the LCD module can be adjusted by simultaneously pressing the escape and up-arrow keys (for more contrast) or the escape and down-arrow keys (for less contrast).

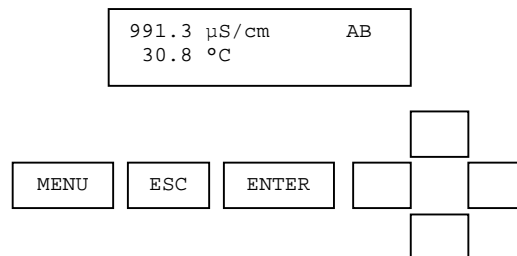



Figure 2.2: The elements of the AV88 user interface.

A pressed key is identified by a gray background, e.g., .

When a sensor module of the same type is replaced in the AV88, current output, PID and relay settings are maintained. If a sensor module of a new type is installed, these settings are automatically set to default conditions appropriate to the new parameter.

The measure screen is the same for all parameters. It displays the sensor value on the top line and the temperature on the bottom line. The AB indicators on the far right side of the top line indicate the state of the relays (when this option is installed). An uppercase letter indicates that the corresponding relay is energized. An underscore indicates that the corresponding relay is de-energized. The example in Figure 2.3 illustrates the display of a conductivity measurement at Station Address 1 with relays A and B energized.

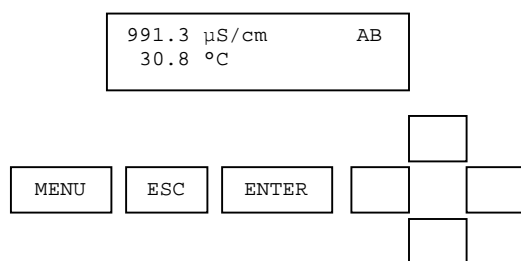

Figure 2.3: The measure screen. It shows the sensor value, sensor units, temperature value, and temperature units.

When the Sensor Module is absent, the condition will be indicated by dashes on the measure screen as shown in Figure 2.4.

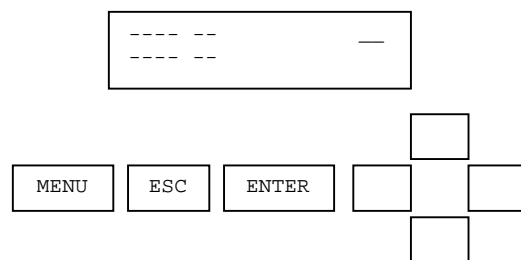

Figure 2.4: The initial measure screen when the Sensor Module is absent.

3. MENU STRUCTURE AND NAVIGATION

Menus are accessed by pressing the MENU key.

The menu structure is navigated using ENTER, UP/DOWN arrows, and ESC keys.

- Use the UP/DOWN arrow keys to scroll through the list of Menu options.
- Use the ENTER key to select an option.
- Use the ESC key to move up in the structure.

The end of the list of menu options is always the EXIT function. Pressing ENTER on the EXIT screen will bring up the MEASURE screen.

The () symbol is used to indicate that the user is in the menu structure. At the leaf of each branch of the menu structure, the user is able to enter a value or make a choice. The value to be entered or the choice to be made will be surrounded by parentheses (()). The name of the value being entered or choice being made will appear on the upper line of the screen and be appended with a question mark (?) to indicate that the user is to provide input.

The right arrow symbol () on the screen indicates that downward navigation through the menu structure is possible. The left arrow symbol () on the screen indicates that upward navigation through the menu structure is possible.

The items in the calibrate and configure menus depend on the type of personality module that is installed in the AV88.

Main menu options are listed as follows:

Main Menu Item	Function
Calibration	Sensor calibration choices are automatically available for installed personality module
Configuration	Configuration choices are automatically available for the installed personality module
Analog Output 1	Set 4 mA and 20 mA values. Calibrate and test the current output with a meter.
Analog Output 2	Set 4 mA and 20 mA values. Calibrate and test the current output with a meter.
PID Controller (option)	Set up PID control functions for analog outputs. Available with pH or conductivity only.
Relay A (option)	Set wash, alarm, or control functions. (Optional)
Relay B (option)	Set wash, alarm, or control functions. (Optional)
Help	Indicates AV88 firmware version
Exit	Returns to the measure screen

MAIN MENU NAVIGATION

- Enter the Main Menu by pressing the MENU key.
- Scroll the listing with the UP/DOWN arrow keys.
- To select an option, press the ENTER key.

The AV88 remembers that last menu option used and will return to that menu option when re-entering the main menu from the measure screen. The list order is always the same so if pressing MENU displays current output and the desired operation is calibration; the UP arrow will be used to move to the Calibrate menu.

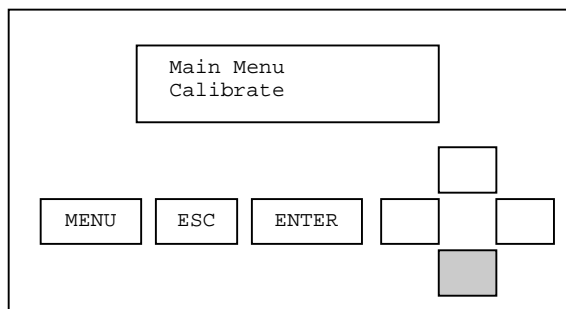

Select **CALIBRATE** with the ENTER key

- To calibrate the main parameter or temperature.

NOTE: Calibrate menus will be sensor specific.

Press the DOWN ARROW for next selection.

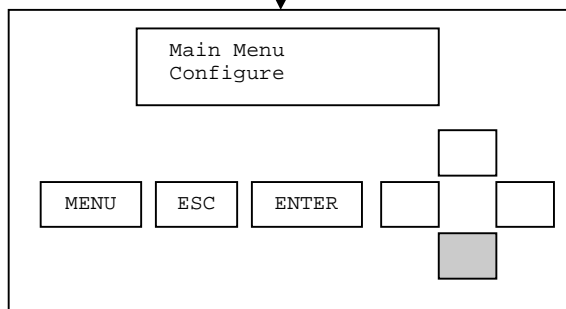

Select **CONFIGURE** with the ENTER key

- To display or change filters, units of measure, constants, tables and buffer standards

NOTE: Configure menus will be sensor specific.

Press the DOWN ARROW for next selection.

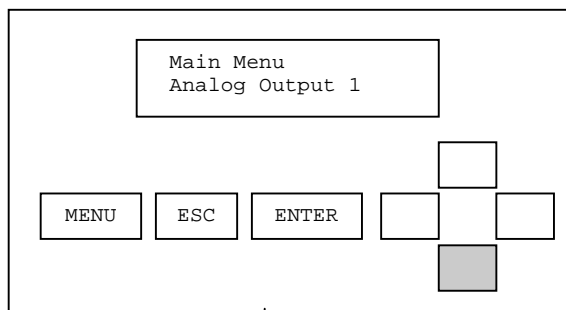

Select **ANALOG OUTPUT 1** with the ENTER key

- To set up 4 to 20 mA Analog Output for sensor, temperature or PID (if Installed).

Press the DOWN ARROW for next selection.

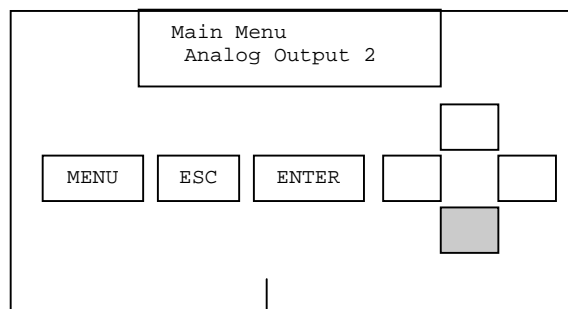

Select **ANALOG OUTPUT 2** with the ENTER key

- To set up 4 to 20 mA Analog Output for sensor, temperature or PID (if installed).

Press the DOWN ARROW for next selection.

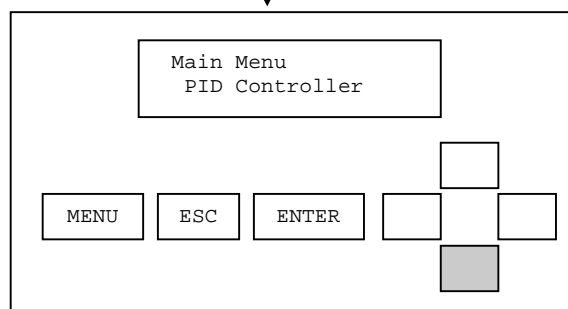

Select **PID CONTROLLER** with the ENTER key

- To set up ISA or Velocity Algorithm, Full-Scale, Zero-Scale, Setpoint, Proportion Gain, Integral Gain, Derivative Gain, Transit time, manual reset and manual mode. (Can be used with pH or Conductivity).

Press the DOWN ARROW for next selection.

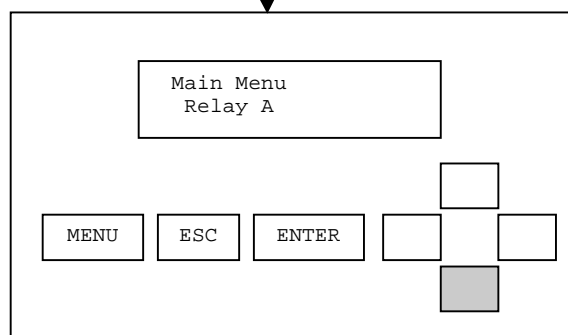

Select **RELAY A** with the ENTER key

- To set up Relay A for Alarm, Control or Wash functions (if installed).

Press the DOWN ARROW for next selection.

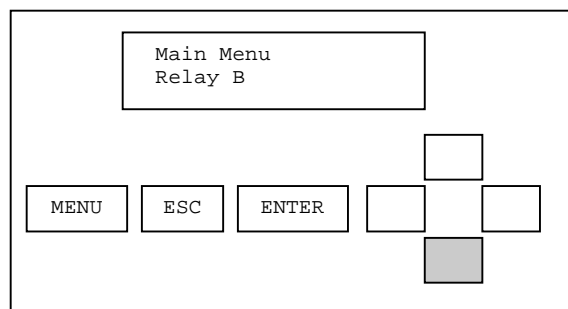

Select **RELAY B** with the ENTER key

- To set up Relay B for Alarm, Control or Wash functions (if installed).

Press the DOWN ARROW for next selection.

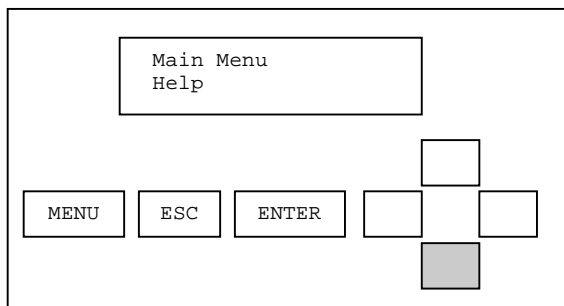

Select **HELP** with the ENTER key

- To read the AV88 firmware version.

Press the DOWN ARROW for next selection.

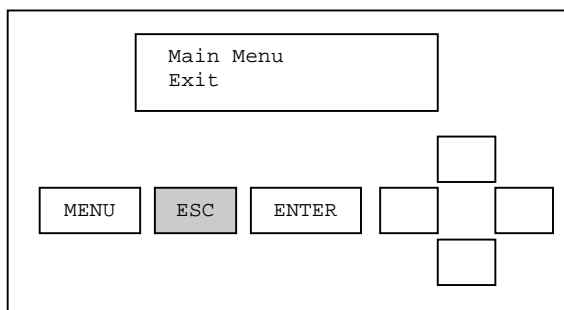

Select **EXIT** with the ENTER key

- Return to the measure screen.

Press an UP ARROW to review the menu.
Press ESC for Measure (alternate method).

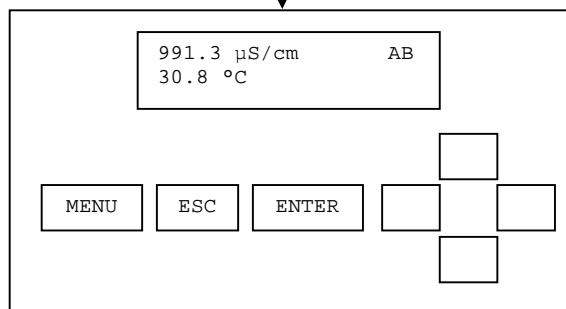

Measure Screen

Note: The relay activity indicators “AB” show that both Relay A and Relay B are energized.

4. CALIBRATE MENUS

Calibration methods supported in the AV88 are automatically available depending on the personality module installed in the AV88. The supported calibration functions are listed below:

Calibration Type	Function	Sensors Supported
1-Point Sample	Set measured reading to desired reading. Changes offset. Best done at high end of range.	All
2-Point Buffer	Automatically sets measured readings to closest buffer standard. Two points separated by more than 2 pH units. Buffer standards are selected in the configuration menu. Changes span and offset.	pH
Zero	Set measured reading to zero. Measured reading must be close to zero.	Conductivity, Turbidity, Dissolved Oxygen, Ozone.
Air	Adjust measured reading to calculated reading of oxygen in air with pressure and salinity configuration settings as well as temperature reading. Assumes sensor is placed in air.	Dissolved Oxygen
Temperature 1-Point	Set measured reading to desired reading. Changes offset. Best done at high end of range.	All
Exit	Returns to the measure screen	

Calibration functions that are not supported in the AV88 but are supported with the Thermo Scientific AquaSensors remote protocol include:

2-Point Sample	Sets measured reading to desired reading for two points separated by more than 2 pH units. Changes span and offset.	NOT supported in AV88 local menu. Accessed through digital network.
1-Point Buffer	Automatically sets measured pH reading to closest buffer standard point. Buffer standards are selected in the configuration menu. Changes offset.	NOT supported in AV88 local menu. Accessed through digital network.

Calibration choices vary depending on which personality module is installed in the AV88.

For the **pH sensor**, calibration options are: 2-point Buffer, 1-point Sample and temperature as shown in Figure 4.1.

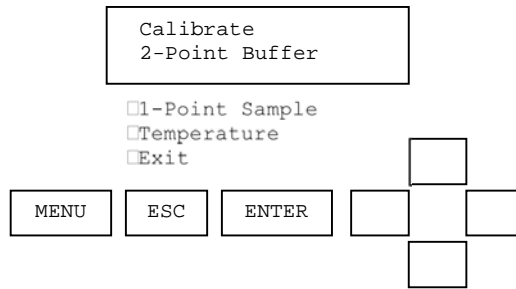

Figure 4.1: The complete calibrate menu for pH.

For the **D.O. sensor**, calibration options are: Air, 1-Point Sample and Temperature as shown in Figure 4.2.

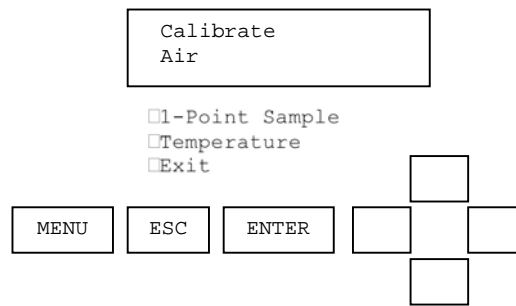

Figure 4.2: The complete calibrate menu for D.O. sensor.

For the **Conductivity and Turbidity sensors**, calibration options are: 1-Point Sample, Zero and Temperature as shown in Figure 4.3. **ORP** sensors have only the 1-point sample calibration and temperature.

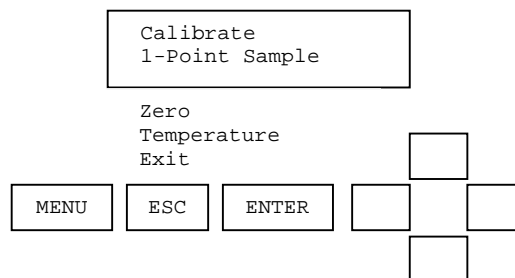
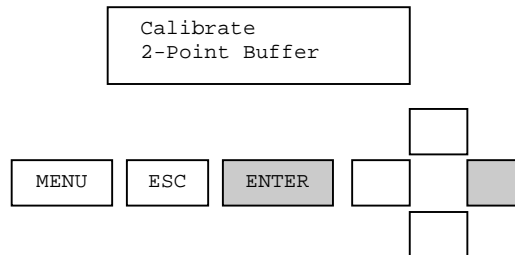

Figure 4.3: The complete calibrate menu for conductivity and turbidity sensors.

4.1. 2-Point Buffer Calibration (Sensor Type: pH)

Find the 2-Point Buffer Calibration in the CALIBRATE menu using the UP/DOWN arrows. Press ENTER to initiate this calibration process. Once the calibration has been initiated it can be aborted by pressing the escape key before the process is completed.



The sensor should be rinsed in DI water and wiped clean to remove any process solution that would otherwise contaminate the buffer solution. When the 2-point buffer calibration procedure is started, the analog output is placed into hold mode and the user is prompted to place the sensor in the first buffer solution. The sensor value is dynamically updated during this step as shown in Figure 4.4.

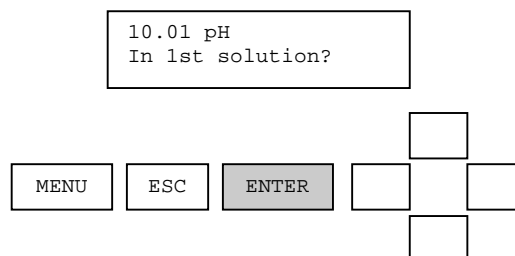
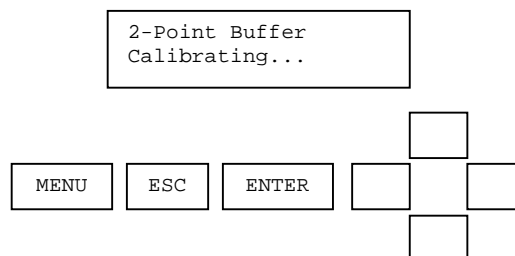

Figure 4.4 Sensor value is dynamically updated.

It is best to let the sensor value stabilize in the buffer solution before initiating the calibration. If the temperature of the sensor is very different from the temperature of the buffer sample, allow some time for the temperature to equilibrate before initiating the calibration. After the sensor is placed in the first buffer, the ENTER key is pressed to start the calibration of the first point.



It takes between 5 seconds and two minutes depending on sensor and temperature measurement stability. Once the calibration has been initiated it can be aborted by pressing the escape key before the process is completed. See Section 4.2 for an example of an aborted calibration procedure.

After the first calibration point has been stored, the user is prompted to place the sensor in the second buffer. The sensor should be rinsed in DI water and wiped clean before it is placed in the second solution.

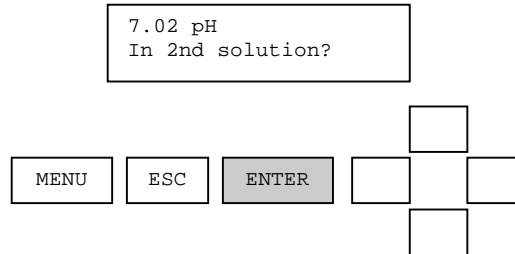

After the sensor is placed in the second buffer, the ENTER key is pressed to start the calibration of the second point.

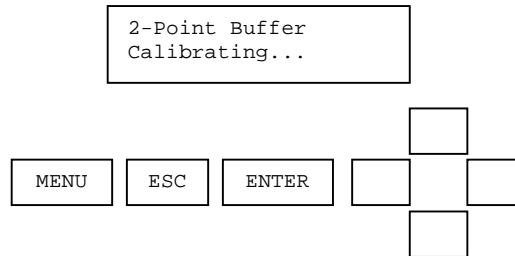

After the second calibration point has been stored, the user is prompted to confirm a successful calibration procedure.

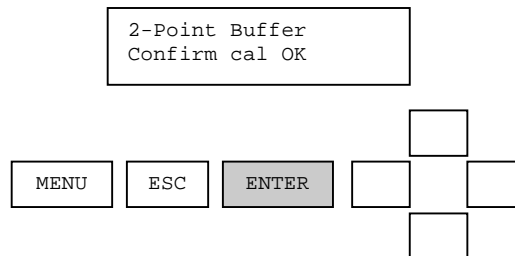

When the ENTER key is pressed to acknowledge that the calibration was successful, the analog output is placed into active mode and the monitoring of sensor and temperature values is resumed. This successfully completes the 2-point buffer calibration procedure.

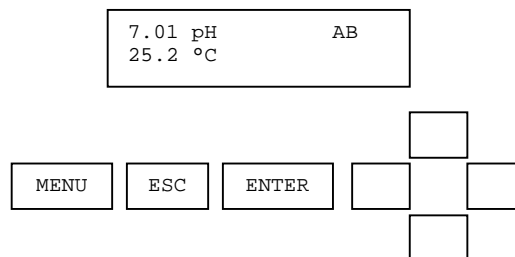

If an error occurs during calibration that causes the procedure to fail, the reason for the failure is shown on the screen.

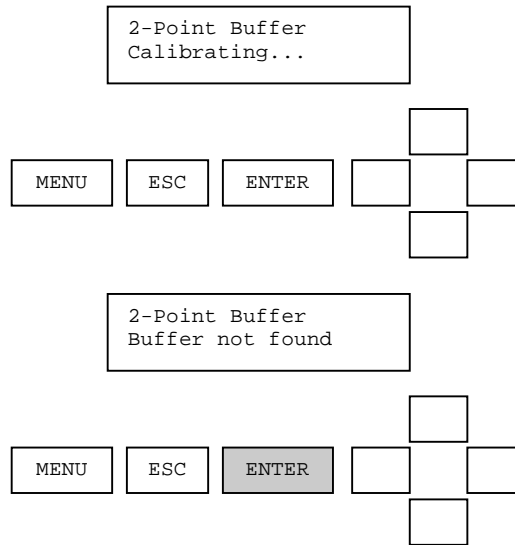

When the ENTER key is pressed, the calibrate menu is displayed. The analog output remains in hold mode. This ends the 2-point buffer calibration procedure. The user has the option of repeating the procedure if desired.

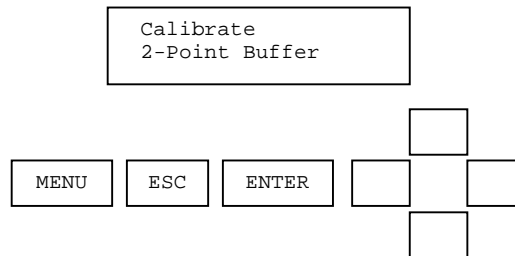

4.2. Aborted Calibration (Sensor Type: All)

If the ESC key is pressed while calibration is in progress, the procedure is aborted. A calibration cannot be aborted if the calibration process has completed.

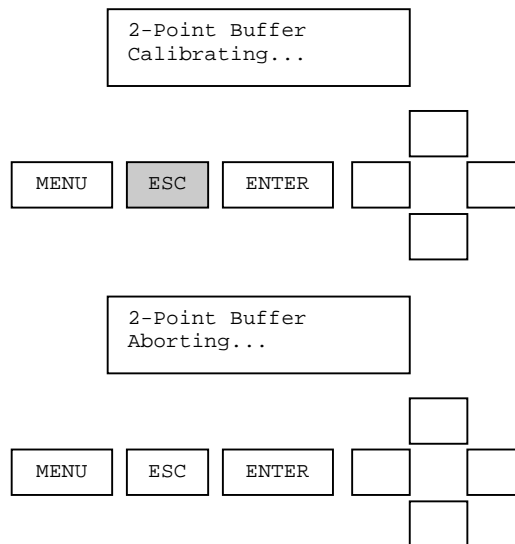

After the calibration procedure has been aborted, the user is prompted to confirm the abort.

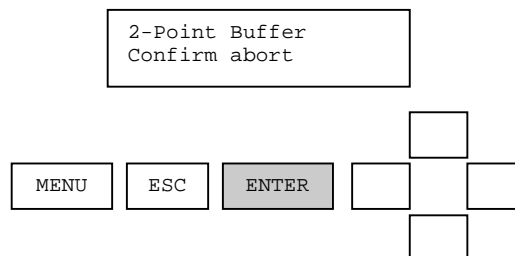

When the ENTER key is pressed, the analog output is placed into the active mode and the monitoring of sensor and temperature values is resumed. This ends the 2-point buffer calibration procedure.

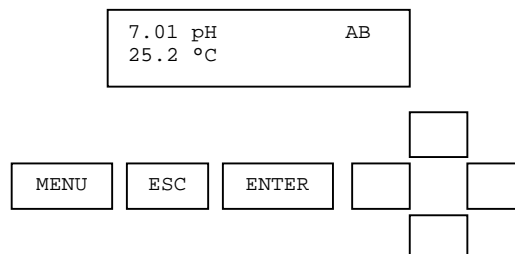

4.3. 1-Point Sample Calibration (Sensor Type: All)

The screen-by-screen example for a 1-point sample calibration is given for a conductivity sensor as shown in Figure 4.5. The same sequence is followed for any sensor type. Only the units of measure and span will change.

Press MENU from the Measure Screen:

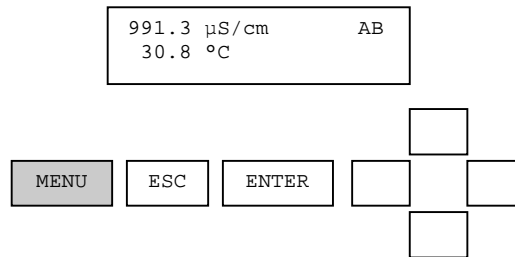

Scroll to CALIBRATE with the UP/DOWN Arrows and press ENTER:

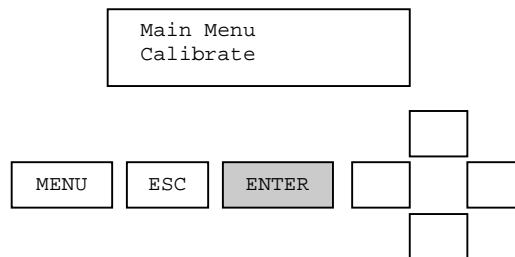

Scroll the list of CALIBRATE options with the UP/DOWN arrows and press ENTER to select 1-POINT SAMPLE.

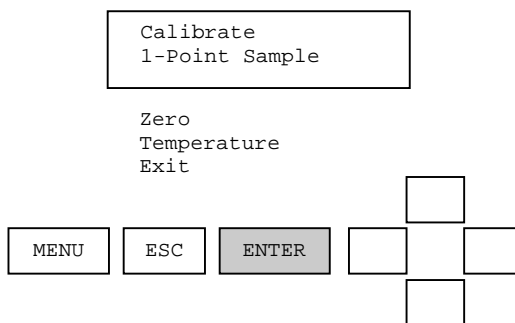
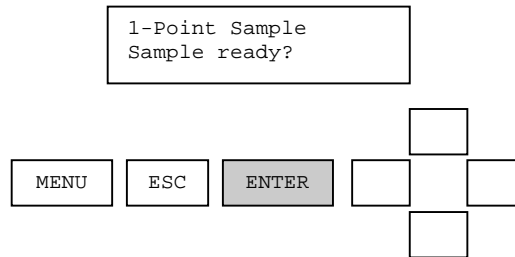

Figure 4.5: The complete calibrate menu for conductivity.

Be sure the sensor has been properly cleaned before calibration. Initiate the 1-point sample process by pressing ENTER.



The sensor value is dynamically displayed at this point in the calibration procedure as shown in Figure 4.6. When the reading has stabilized, press ENTER to initiate the calibration.

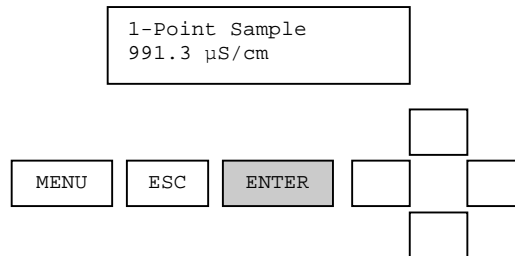

Figure 4.6: Dynamic display of the sensor value during calibration.

When the user presses enter, the current sensor value is captured and shown in the edit field of the next screen as shown in Figure 4.7.

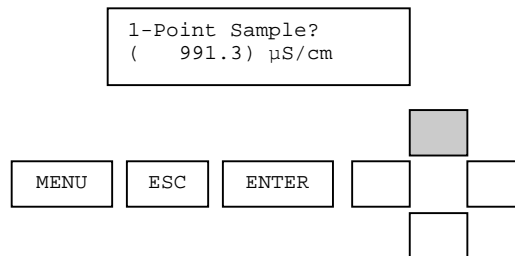

Figure 4.7: The calibration edit screen.

The calibration value can be adjusted with the UP and DOWN arrow keys. After the calibration value is adjusted, the ENTER key is pressed to calibrate the sensor as shown in Figure 4.8.

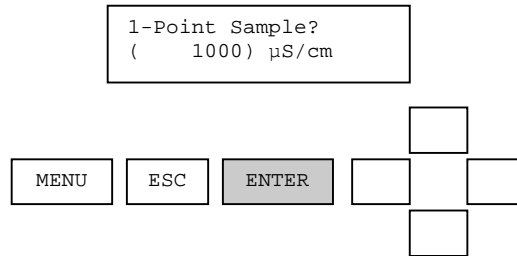
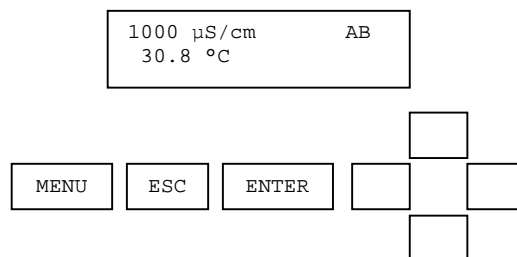
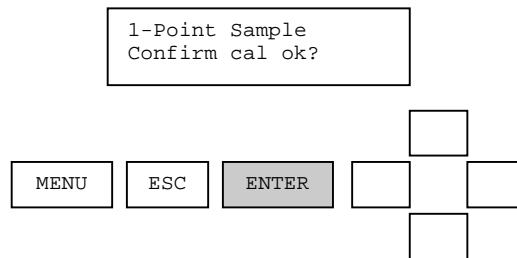
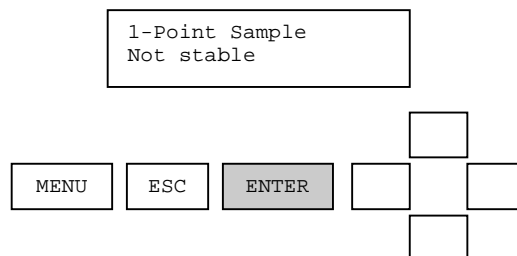

Figure 4.8: Entering the calibration value.

After the calibration process is complete, the user is asked to confirm the result before releasing the current outputs, relays and measure screen.



If an error occurs during calibration, the reason for the failure is shown.



4.4. Zero Calibrate Menu (Sensor Type: Conductivity, DO, Turbidity)

The complete zero calibration menu for conductivity is shown in Figure 4.9. The same calibration sequence also applies to turbidity, suspended solids, dissolved oxygen and ozone.

From the Calibrate menu, use the UP/DOWN arrows to display ZERO calibration. Press ENTER to select.

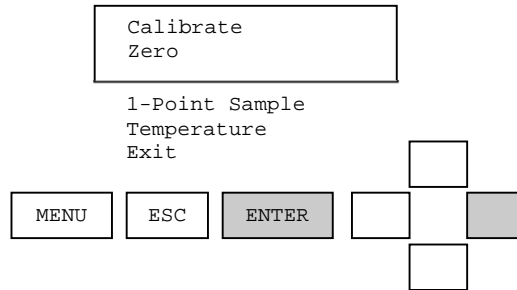
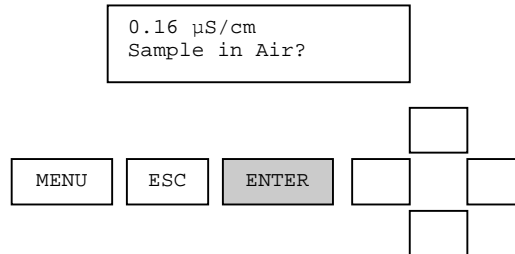

Figure 4.9: The complete zero menu for conductivity

Be sure conductivity sensors are dry and suspended away from objects that could affect the measurement in air. Press ENTER to initiate zero calibration.



A zero calibration may take some time as the zero must be calibrated over a wide dynamic range. During this process the CALIBRATING... message is shown in Figure 4.10.

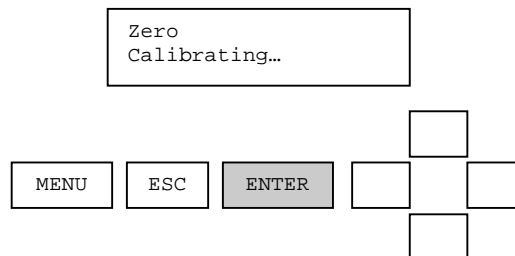
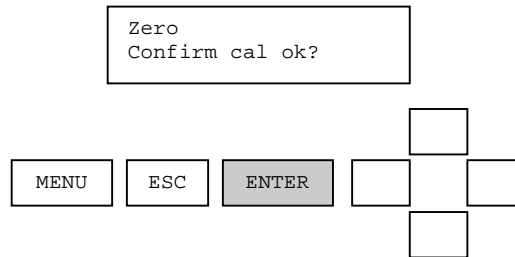
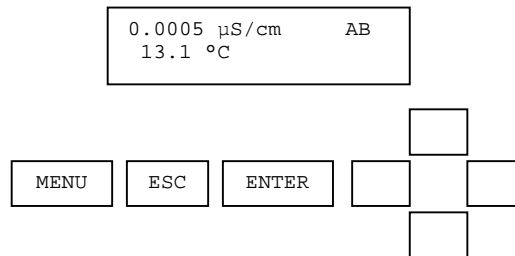

Figure 4.10: Zero is Calibrating....

When the zero calibration is complete, the user will be asked to confirm the result with the ENTER key.



After pressing ENTER to confirm Calibration is okay, the Measure screen will be displayed.



If an error occurs during calibration, the reason for the failure is shown.

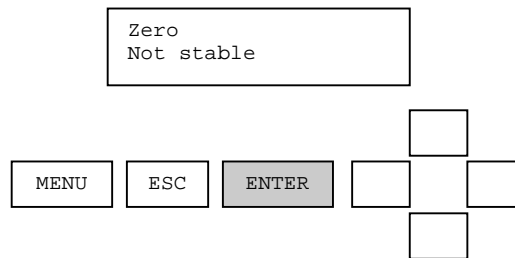

Press ENTER to acknowledge the calibration failure and return to the measure screen.

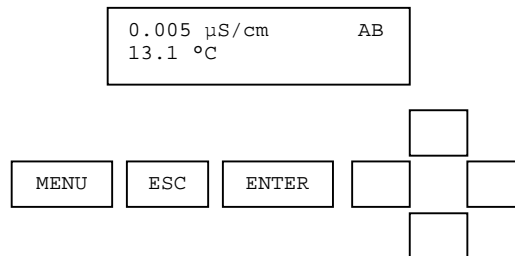

4.5. Air Calibration (Sensor Type: D.O.)

An AIR CALIBRATION computes the oxygen content measured in air based on the setting for PRESSURE, SALINITY and the measured temperature. View or change the Pressure and Salinity settings in the CONFIGURE menu.

Initiate the AIR CALIBRATION process by pressing ENTER.

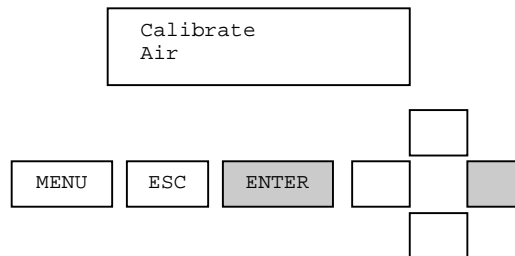

Figure 4.11: Air calibrate menu for D.O.

When the air calibration procedure is initiated, the analog output is placed into hold mode. The user is prompted to place the sensor in air as shown in the Figure 4.12.

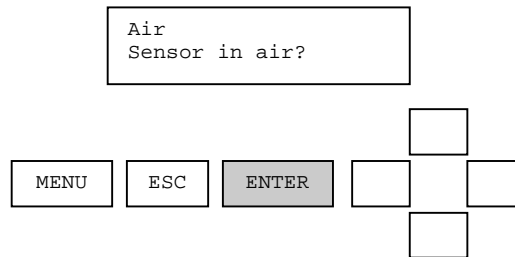
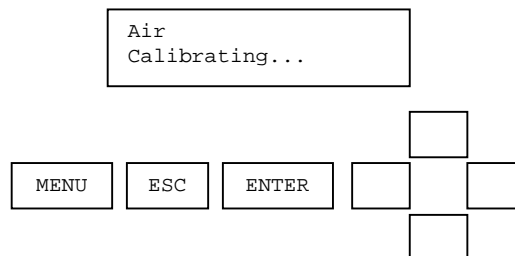

Figure 4.12 The user is prompted to place the sensor in air.

After the sensor is placed in air, press the ENTER key to start the calibration.



It takes between 5 seconds and two minutes depending on sensor and temperature measurement stability. During this time, the calibration procedure can be aborted by pressing the ESC key. See Section 4.2 for an example of an aborted calibration procedure.

After the air calibration point has been stored, the user is prompted to confirm a successful calibration procedure.

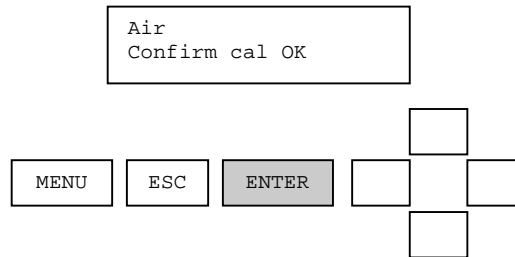

When the ENTER key is pressed, the analog output is placed into active mode and the monitoring of sensor and temperature values is resumed. This successfully completes the air calibration procedure.

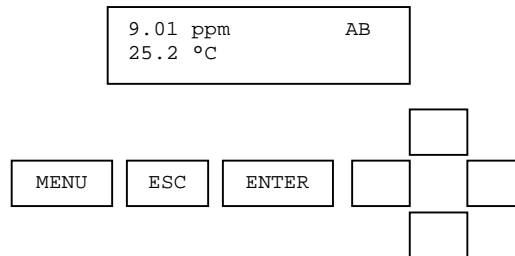

If an error occurs during calibration that causes the procedure to fail, the reason for the failure is shown on the screen.

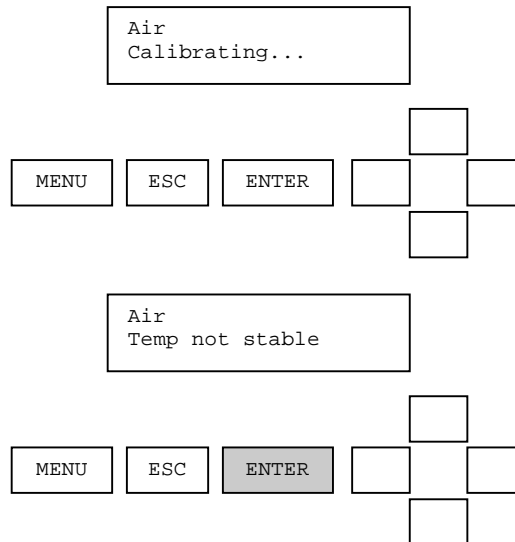

When the ENTER key is pressed, the calibrate menu is displayed. The analog output remains in hold mode. This ends the air calibration procedure. The user has the option of repeating the procedure if desired.

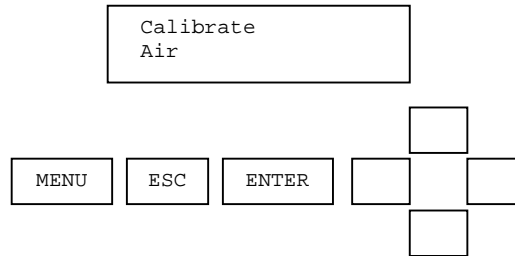

4.6. Temperature 1-Point Sample Calibration

Press the ENTER key from the TEMPERATURE calibration menu to initiate the calibration process.

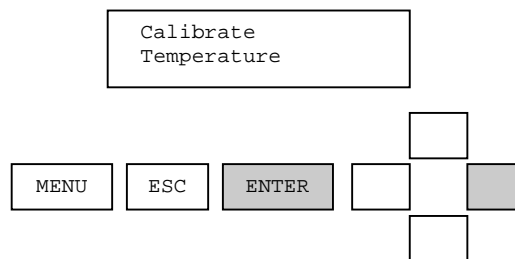

When the temperature calibration procedure is started, the analog output is placed into hold mode. The user is prompted to prepare the sensor. The sensor value is dynamically updated during this step as shown in Figure 4.13.

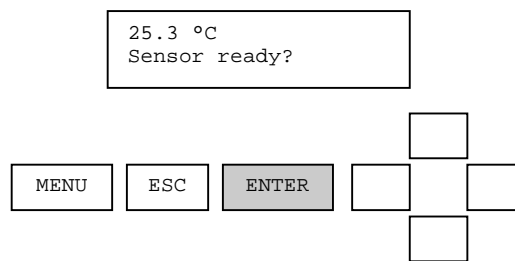

Figure 4.13: The temperature value is dynamically updated while the user is prompted to prepare the sensor.

When the sensor is ready, the ENTER key is pressed and the user is presented with a calibration value for editing as shown in Figure 4.14. Please note that it is best to calibrate temperature with the sensor in an aqueous solution. Response time for calibration in air is slower.

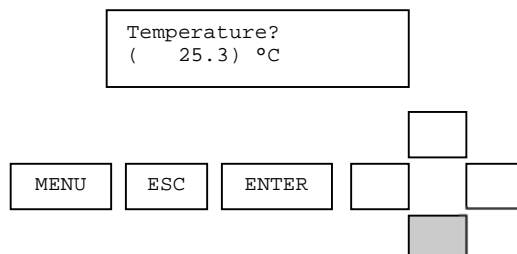
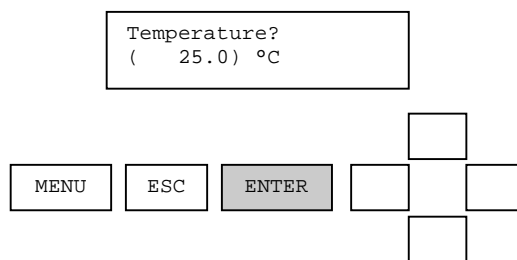
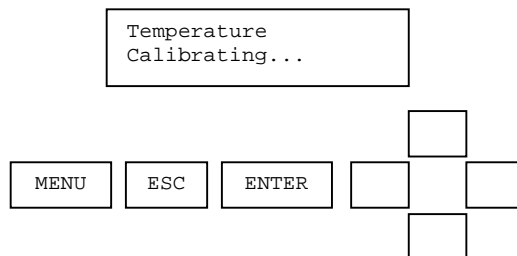

Figure 4.14: The calibration value is presented for editing.

When the value has been edited as desired, the enter key is pressed and the calibration of the point is started.



During this time, the calibration procedure can be aborted by pressing the ESC key. See Section 4.2 for examples of an aborted calibration procedure.



After the calibration point has been stored, the user is prompted to confirm a successful calibration procedure.

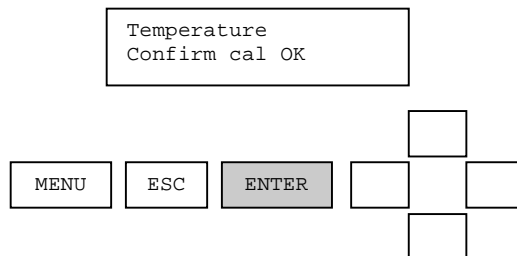

When the ENTER key is pressed, the analog output is placed into active mode and the monitoring of sensor and temperature values is resumed. This successfully completes the temperature calibration procedure.

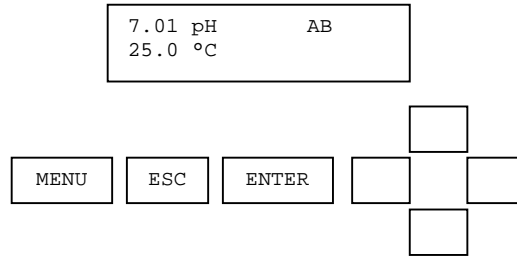

If an error occurs during calibration that causes the procedure to fail, the reason for the failure will be shown.

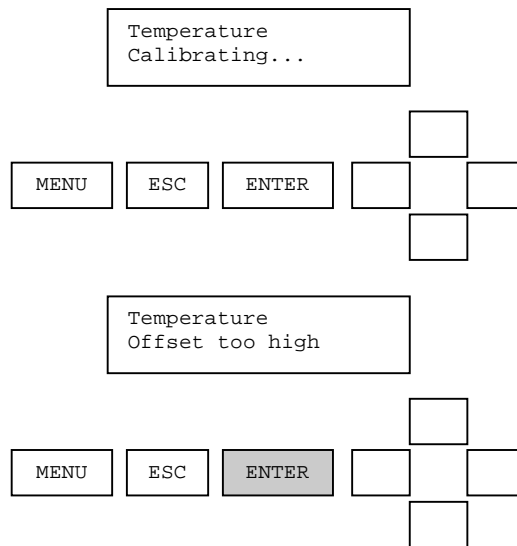

When the ENTER key is pressed, the calibrate menu is displayed. This ends the temperature calibration procedure. The user has the option of repeating the procedure if desired.

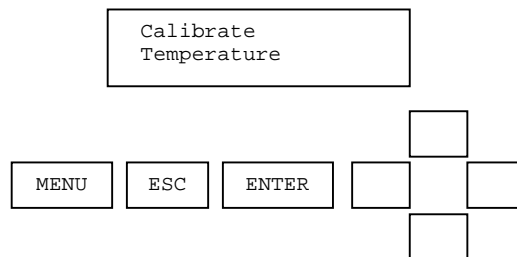

5. CONFIGURE MENU

The configuration menu allows viewing and editing of sensor constants and will depend on the type of personality module installed in the AV88.

Configuration Type	Function	Sensors Supported
Sensor Filter	Filter main parameter in seconds. Set zero seconds for no filter. Set up to 100 seconds for time to reach 90% of final value. 1 to 5 seconds should be optimal for most applications.	All
Sensor Units	PH: pH or mV ORP: mV Conductivity: uS/cm, %, TDS, MΩ·cm D.O./Ozone: ppm Turbidity: NTU	All
Temperature Filter	Filter temperature in seconds. Set zero seconds for no filter. Set up to 100 seconds for time to reach 90% of final value. 1 to 5 seconds should be optimal for most applications. The temperature filter value should generally be set to the same value as the sensor filter.	All
Temperature Units	Select Centigrade or Fahrenheit.	All
Buffer Standard	Select 4, 7, 10 pH or DIN Standard (1.09, 4.65, 6.79, 9.23 and 12.75).	pH
Cell Constant	View or change the Cell constant	Conductivity
Reference Temperature	Conductivity reference temperature is set from 0°C to 100 °C	Conductivity
Comp Slope	Slope is set from 0 to 9.9%/°C	Conductivity
TDS Conversion Factor	A factor is set to convert measured conductivity to ppm	Conductivity
Salinity	Salinity compensation is set from 0 to 999.9mS/cm	D.O., Ozone
Pressure	Pressure is set from 539.2 to 792.4 mmHg	D.O., Ozone

Configuration Type	Function	Sensors Supported
Concentration Table	A 10-point concentration table is entered to convert measured conductivity into % concentration	Conductivity
Exit	Returns to the measure screen	

5.1. Main Configure Menus

Configure menus dynamically change depending on the personality module installed in the AV88. Generally, all configure screens allow viewing and editing values in parentheses. Examples of top-level menus for conductivity, pH, DO and Turbidity are shown below.

The complete configure menu for **Conductivity** is shown in Figure 5.1.

```

Configure
Sensor Filter

Sensor Units
Temp Filter
Temp Units
Cell Constant
Reference Temp
Comp Slope
TDS Conv Factor
Conc Table
Exit

```

Figure 5.1: The complete configure menu for conductivity.

The complete configure menu for pH is shown in Figure 5.2.

```

Configure
Sensor Filter

Sensor Units
Temp Filter
Temp Units
Buffer Standard
Exit

```

Figure 5.2: The complete configure menu for pH.

The complete configure menu for D.O. is shown in Figure 5.3.

```

Configure
Sensor Filter

Sensor Units
Temp Filter
Temp Units
Salinity
Pressure
Exit

```

Figure 5.3: The complete configure menu for D.O.

The complete menu for turbidity is shown in Figure 5.4.

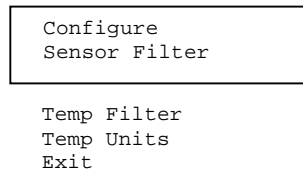
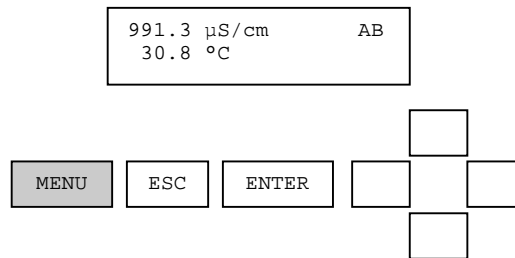

Figure 5.4: The complete configure menu for turbidity.

5.2. Navigating Sensor Filter Configuration

The following sequence shows how the sensor filter configuration is viewed and set. The gray key is pressed to move to the next screen. This sequence is an example for all configuration menus.

From the Measure Screen, Press the MENU key:



Scroll to the CONFIGURE Menu with the UP and DOWN arrows:

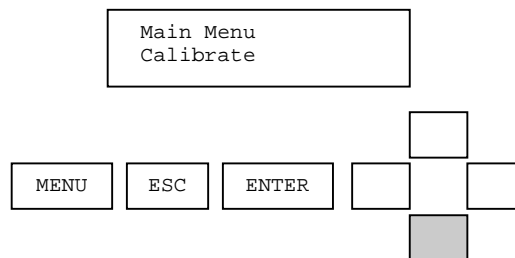

Select ENTER when CONFIGURE is displayed:

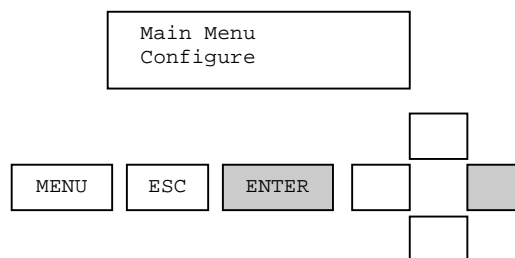

Scroll to SENSOR FILTER using the UP and DOWN arrows:

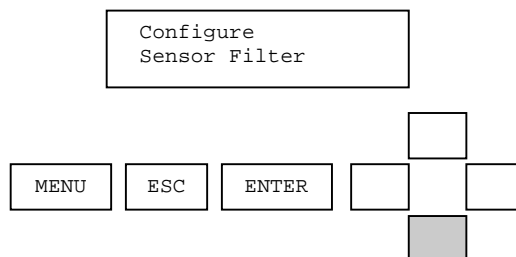

Select SENSOR FILTER using the ENTER key:

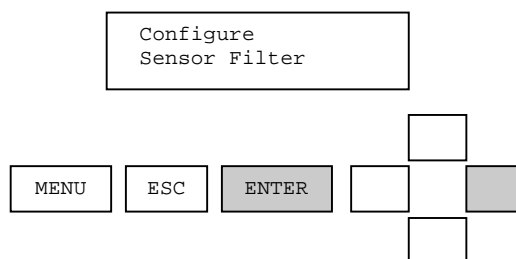

Use the UP and DOWN arrow keys to change the number in parentheses to the desired sensor filter (in seconds):

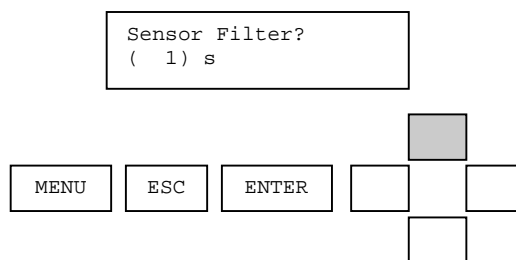

Press the ENTER key to keep the filter setting currently in parentheses. Or press the ESC key to leave the filter setting unchanged.

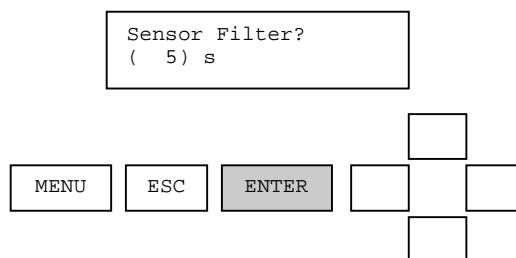

After editing or viewing the filter setting, return to the Main Configure screen with the ESC key.

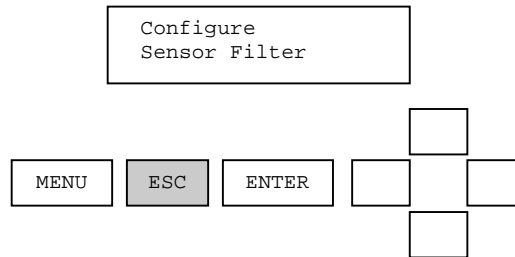

When finished with MENU functions return to the Main Configure screen with the ESC key.

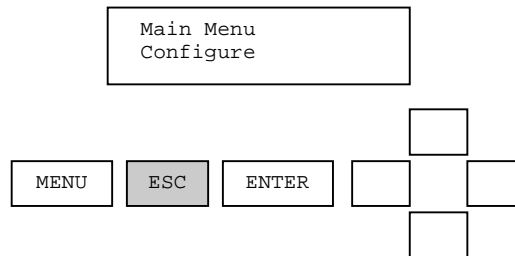

Observe the response time of the measurement. The temperature filter should also be changed to the same filter value.

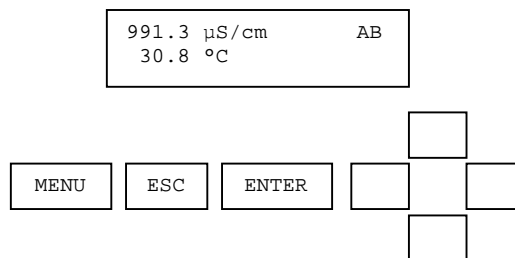

5.3. Navigating the User-Entered Concentration Table Screens

The AV88 can convert measured conductivity into % concentration based on a 10-point user-entered concentration table. This feature is available for contacting and toroidal conductivity only. To enable this feature, set the Sensor Units to % in the Configure menu. The measured values will be displayed as shown below:

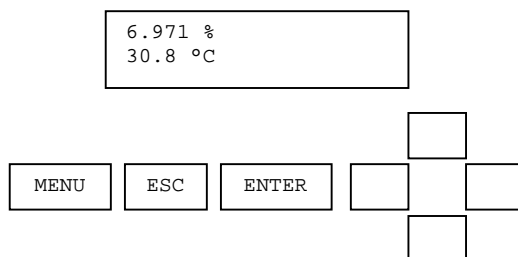

The table can be accessed using the AV88's user interface. Each point in the table is composed of two coordinates, conductivity and concentration. The conductivity coordinate is also known as the X coordinate, and the concentration coordinate is also known as the Y coordinate.

Concentration Table Requirements

The table can have up to 10 points. If the table has fewer than 10 points, the last point in the table must be set to 0 $\mu\text{S/cm}$ and 0%. Thus a typical table with four points will have the form shown in Table 1:

Table 1: A typical concentration table with four points.

Point	Conductivity X Coordinate ($\mu\text{S/cm}$)	Concentration Y Coordinate (%)
1	0	0
2	1,000	10
3	5,000	50
4	10,000	99.99
5	0	0
6	0	0
7	0	0
8	0	0
9	0	0
10	0	0

Note: The coordinate values of 0 $\mu\text{S/cm}$ and 0% in point 5 indicate the end of the table. Because point 5 is the end of the table, points 6-10 are ignored.

- The conductivity coordinates must be monotonic¹ over the range of interest and increasing in value and be between 0 and 2,000,000 $\mu\text{S/cm}$.
- The concentration coordinates must also be monotonic¹ over the range of interest, but can be either increasing or decreasing and must be between 0 and 99.99%.

¹ Monotonic means consistently increasing and never decreasing or consistently decreasing and never increasing in value.

Before entering the concentration table values, use Table 2 to record the values to be entered.

Table 2: Record the table values here before entering them.

Point	Conductivity X Coordinate ($\mu\text{S}/\text{cm}$)	Concentration Y Coordinate (%)
1		
2		
3		
4		
5		
6		
7		
8		
9		
10		

Entering the Concentration Table

The concentration table editing screen can be reached by navigating to the Configure menu, scrolling down to the Conc Table item, and then pressing Enter.

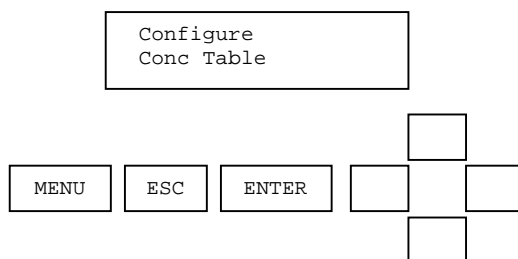

When the Conc Table screen is first entered, all ten points in the table are read. While the points are being read, the screen counts down from 10 to 1.

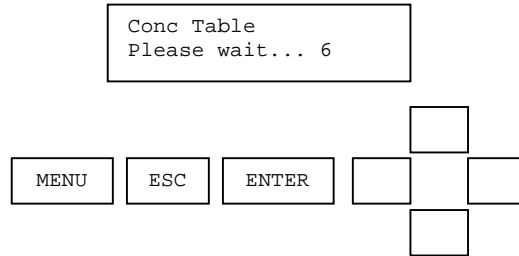

After all ten points have been read, the conductivity coordinate for the first point is shown.

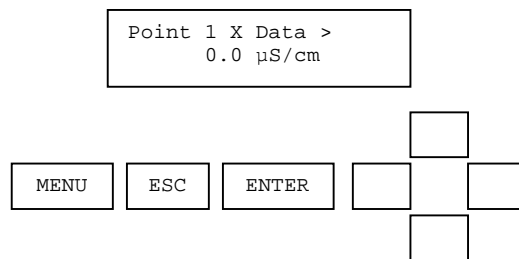

To view the corresponding concentration coordinate, press the RIGHT arrow key.

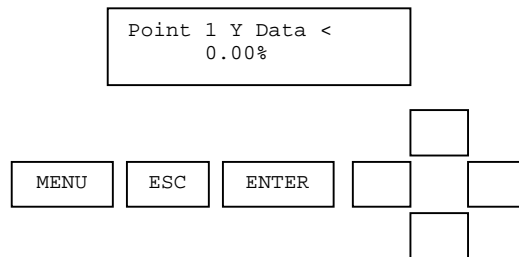

To view the second point in the table, press the DOWN arrow key.

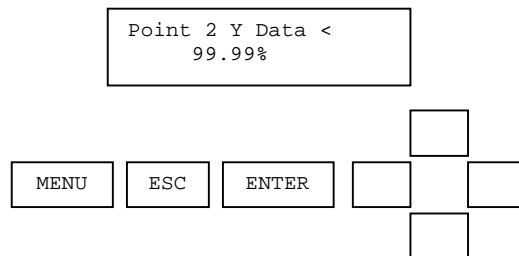

All of the points in the table can be reviewed by using the UP, DOWN, LEFT, and RIGHT arrow keys.

To edit a coordinate, navigate to the desired coordinate using the UP, DOWN, LEFT, and RIGHT arrow keys and press ENTER. The present value of the coordinate will appear within parentheses. The parentheses indicate that the value can be edited.

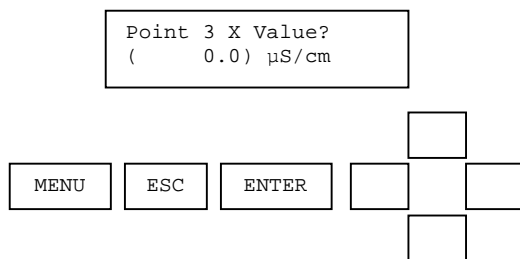

Use the UP, DOWN, LEFT, and RIGHT arrow keys to change the coordinate value as desired.

- The UP and DOWN arrow keys increment and decrement, respectively, the value by a small amount. Pressing and holding the UP or DOWN key increments and decrements the value by a slightly larger amount and at a higher rate. These keys provide a fine adjustment.
- The RIGHT and LEFT arrow keys increment and decrement, respectively, the value by a large amount. Pressing and holding the RIGHT or LEFT arrow key increments and decrements the value by an even larger amount and at a higher rate. These keys provide a coarse adjustment.

When the desired points have been entered, press the ESC key. You will be prompted to exit the table.

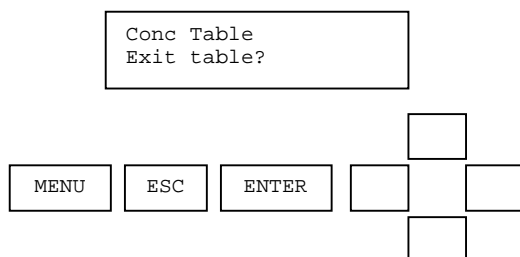

Press ENTER to exit the table or press ESC to return to the table to do more editing. If ENTER is pressed and one or more points have been changed, you will be prompted to save the changes.

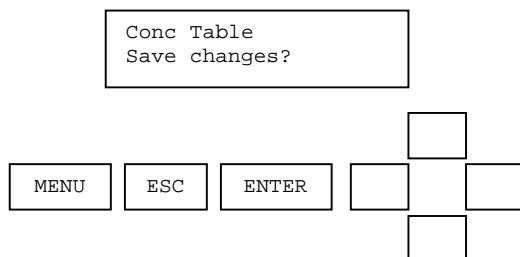

Press ENTER to save the changes or ESC to discard them.

If the changes do not meet the Concentration Table Requirements listed above, you will be informed.

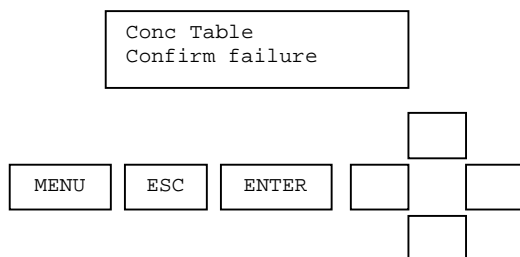

To abort the changes, press the ESC key and then press the ENTER key to confirm the abort.

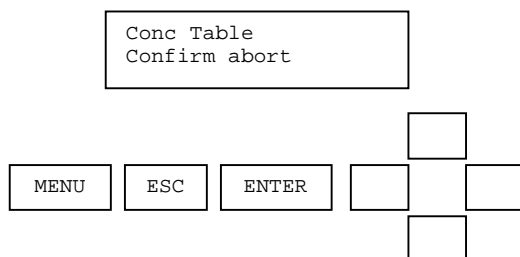

To return to the edit screen and make corrections, press the ENTER key.

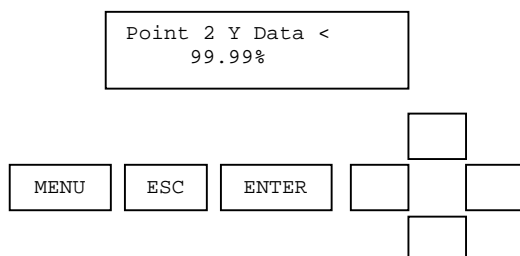

A summary of the actions of the various keys for the viewing and editing modes is shown in Table 3.

Table 3: Summary of key actions.

Mode	Action	Press
Viewing	Scroll X and Y	LEFT and RIGHT arrow
	Scroll point	UP and DOWN arrow
	Edit coordinate (enter editing mode)	ENTER
	Leave the table	ESC
Editing	Change coordinate value	UP and DOWN (fine change) LEFT and RIGHT (gross change)
	Save new value and return to viewing mode	ENTER
	Leave coordinate value unchanged (return to viewing mode)	ESC

Default Concentration Table

The default concentration table is shown in Table 4:

Table 4: The default concentration table.

Point	Conductivity X Coordinate ($\mu\text{S}/\text{cm}$)	Concentration Y Coordinate (%)
1	0	0
2	20,000	99.99
3	0	0
4	0	0
5	0	0
6	0	0
7	0	0
8	0	0
9	0	0
10	0	0

Using the default table, if the measured conductivity is 10,000 $\mu\text{S}/\text{cm}$, then the concentration will be 50%.

6. HOST COMMUNICATIONS

The AV88 can be set up to communicate with a Host Computer system in a variety of protocols. When using Host Communications, please refer to the selected communications manual for specific protocol setup and use.

Host Protocol	Reference Manual to Set up Address, Baud Rate and Parity
Modbus RTU	Modbus Communications Adapter Users Manual (MAN021CA-4)
DeviceNet	DeviceNet Communications Adapter Users Manual (MAN022CA-2)
RS-232	DataStick Instruction Manual (MAN011DS-3): 9600 bps, no parity, 8 data bits, 1 stop bit
Profibus	Modbus/Profibus Gateway Manual
Other	Look for addendums on setting up other protocols that may be configured.

7. ANALOG OUTPUT MENUS

Two 4 to 20 milliamp analog outputs are provided for traditional data reporting. While the AV88 is being used to calibrate the sensor, the analog output is held at its present value.

The analog output menu is used to scale the analog output in the AV88. The following selections are available for each output:

- PARAMETER is used to select SENSOR, TEMPERATURE or PID CONTROLLER (if installed with pH sensor) to drive the current loop. Note that if PID is selected, setting up 4 mA and 20 mA values is not necessary or available. Settings for PID are set up separately in the PID section of the main menu.
- SET 4 mA VALUE is used to edit the lowest sensor or temperature value to be reported. The default value will be the lowest possible reading for the parameter selected.
- SET 20 mA VALUE is used to edit the highest sensor or temperature value to be reported. The default value will be the highest possible reading for the parameter selected.
- The CALIBRATE feature is used to fine-tune the milliamp readings when necessary. An ammeter is connected in series with the load for adjustment of the 4 mA value and the 20 mA value.

7.1. Assigning 4 mA and 20 mA parameter values

Press MENU from the Measure screen

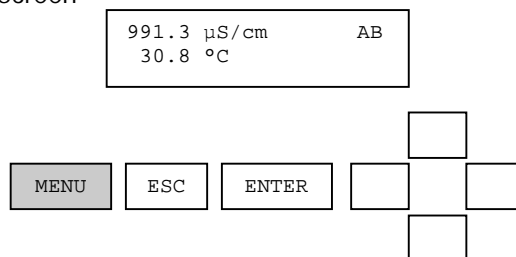

Use the UP/DOWN arrows to select Analog Output (or Analog Output 1, Analog Output 2 depending on hardware options).

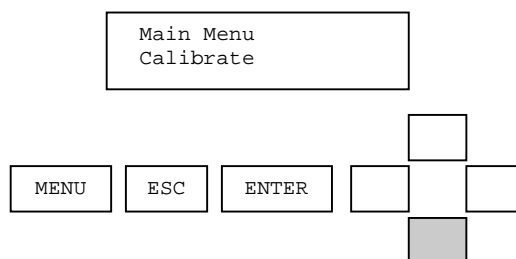

Use the ENTER key to configure the Analog Output of choice. In this example Analog Output 1 is shown.

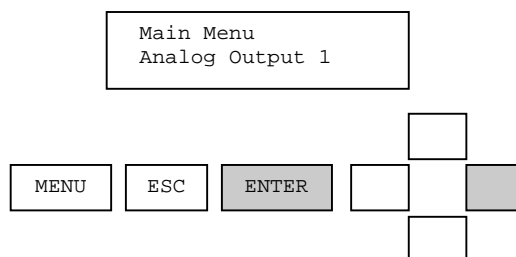

Use the UP/DOWN arrows to scroll through the Analog Output configuration options of Set 4 mA Value, Set 20 mA Value and Calibrate.

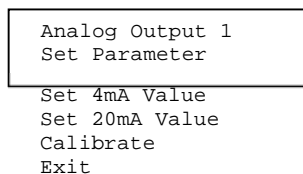
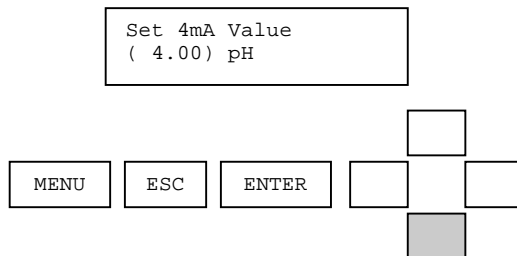
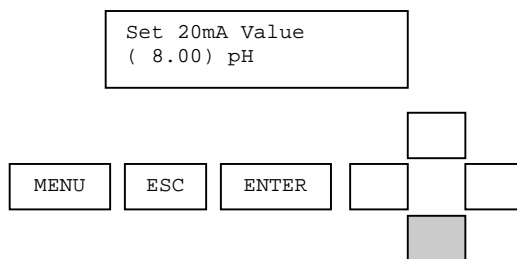

Figure 8.1: The complete analog output menu.

Select **SET 4 mA** option with the ENTER key. Adjust the parameter value with the UP/DOWN arrow keys. Press ENTER to accept the value in parentheses. Press ESC to leave the value unchanged.



Select **SET 20 mA** setting with the ENTER key. Adjust the parameter value with the UP/DOWN arrow keys. Press ENTER to accept the value in parentheses. Press ESC to leave the value unchanged.



7.2. Calibrating Output Current

To make adjustments to the 4 mA and 20 mA values, find the CALIBRATE option with the UP/DOWN arrow keys in the Analog Output menu and press ENTER to select it.

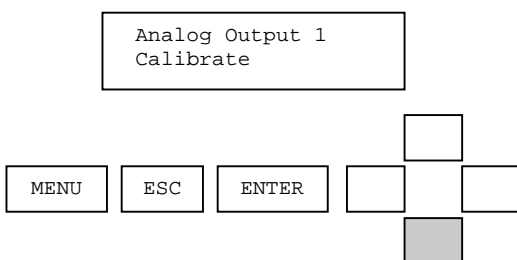

Connect an ammeter in series with the load and Select **4 mA Point** with the ENTER key.

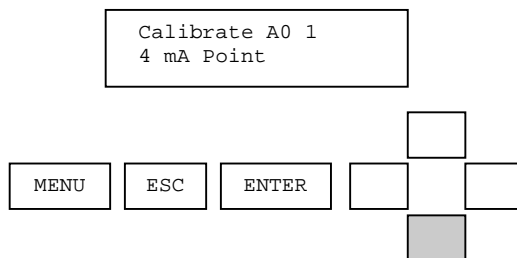

The ammeter should read exactly 4.00 mA. If not, adjust the value displayed on the meter using the AV88 UP/DOWN arrow keys. The number displayed in parentheses is in "counts" and should be within 20% of 2500. Press ENTER to accept the value in parentheses. Press ESC to leave the value unchanged.

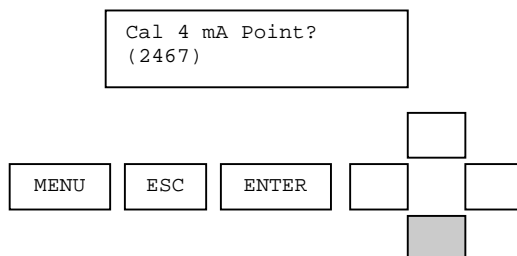

From the Analog Output Calibrate Menu, use the UP/DOWN arrows to display the 20 mA Point. Select with the ENTER key.

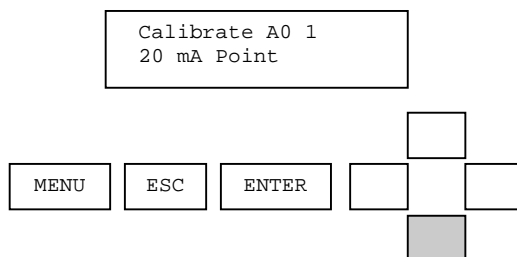

The ammeter should read exactly 20.00 mA. If not, adjust the value displayed on the meter using the AV88 UP/DOWN arrow keys. The number displayed in parentheses is in "counts" and should be within 20% of 12,500. Press ENTER to accept the value in parentheses. Press ESC to leave the value unchanged.

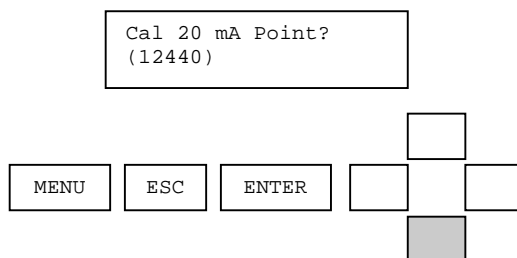

From the Analog Output Calibrate Menu, Press ESC to move back up the MENU tree to the Measure screen.

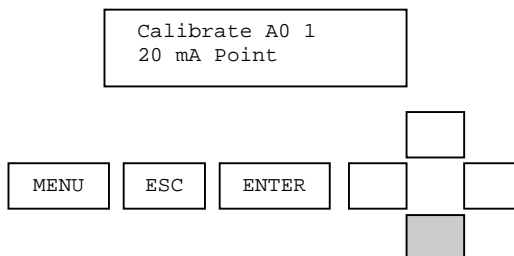

8. PID CONTROLLER

The PID Controller is present in the Main Menu list when a pH or conductivity personality module is installed in the AV88. Press ENTER to select PID CONTROLLER.

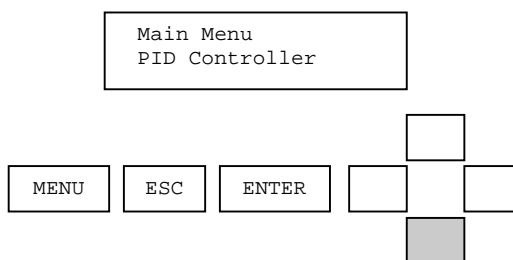

Use the UP/DOWN arrows to scroll the list of PID Controller options for viewing and editing.

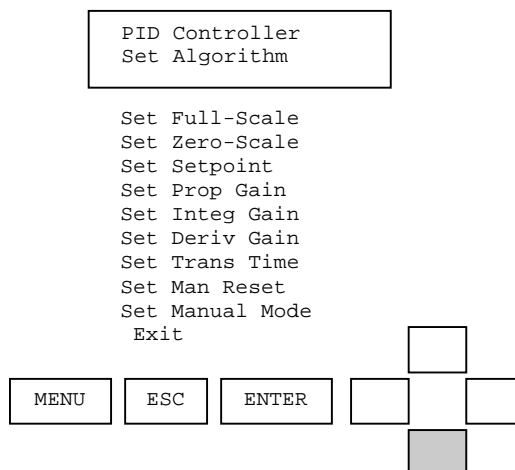

Each of the PID options used to configure and tune the loop is shown below for a sensor type of pH.

PID Function	Edit Range	Default Setting
Set Algorithm	ISA or Velocity	ISA
Set Full-Scale	0 to 14 pH	14 pH (Do not change)
Set Zero-Scale	0 to 14 pH	0 pH (Do not change)
Set Setpoint	0 to 14 pH	7 pH
Set Proportional Gain	99.99 to +99.99	0.00 (+ is direct action, - is reverse action)
Set Integral Gain	0.00 to 50.00 reps/min	0.00 reps/min
Set Derivative Gain	0.00 to 10.00 seconds	0.00 seconds
Set Transit Time	0 to 9999 seconds	0 seconds
Set Man Reset	0.0% to 100%	0.0%
Manual Mode	Control: 0.0% to 100%	0.0% (Process value is displayed)

Scroll through these configuration and tuning options with UP/DOWN arrows. Press ENTER to select an option and view or edit the setting. Press ENTER to change setting or ESC to leave a setting unchanged.

Note that in the Manual Mode, the present pH value is displayed in the top line and the Control Adjustment is made in the second line.

Each of the PID controller options used to configure and tune the loop is shown below for a sensor type of contacting or electrodeless conductivity.

PID Function	Edit Range	Default Setting
Set Algorithm	ISA or Velocity	ISA
Set Full-Scale	0 to 5000 $\mu\text{S/cm}$	2000 $\mu\text{S/cm}$ (Do not change)
Set Zero-Scale	0 to 5000 $\mu\text{S/cm}$	0 $\mu\text{S/cm}$ (Do not change)
Set Setpoint	0 to 5000 $\mu\text{S/cm}$	1000 $\mu\text{S/cm}$
Set Proportional Gain	-99.99 to +99.99	0.00 (+ is direct action, - is reverse action)
Set Integral Gain	0.00 to 50.00 reps/min	0.00 reps/min
Set Derivative Gain	0.00 to 10.00 seconds	0.00 seconds
Set Transit Time Bookmark not defined.	0 to 9999 seconds	0 seconds
Set Manual Reset	0.0% to 100%	0.0%
Manual Mode	Control: 0.0% to 100%	0.0% (Process value is displayed)

When the configuration and tuning settings are made, select PID as the Parameter for current loop 1 or current loop 2.

Integral gain can be disabled by entering "0.00" to provide only PD controller action.

To quickly get to the PID controller set point for fine tuning, press the ENTER and RIGHT ARROW KEYS at the same time from a measure screen. This feature is present only when the personality module installed in the AV88 is pH, contacting conductivity or toroidal conductivity.

9. RELAY MENUS

Up to two Form C relays with normally open and normally closed contacts are available with the AV88. When relay A is energized or activated, an "A" will appear in the upper right corner of the measure display. If relay B is energized a "B" will appear as shown:

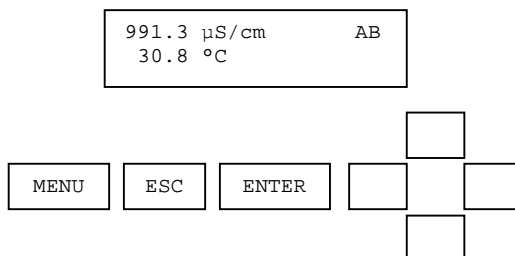

The selectable features in the relay menus are the same regardless of the type of personality module installed in the AV88. While the AV88 is being used to calibrate the sensor, the relay is held in its present state. Use the UP/DOWN arrows to scroll the relay option list. Press ENTER to select. Press ESC to move up a level in the menu system.

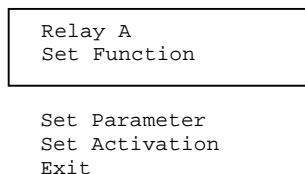

The SET FUNCTION menu is used to configure a relay for ALARM, CONTROL or WASH functions. When ALARM is selected, the relay activation is determined by low and high limits of the chosen measured parameter. When CONTROL is selected, the relay activation is determined by a single set point. WASH is a timer function and does not depend on the sensor or temperature measurements.

- First select the desired relay function: ALARM, CONTROL or WASH.
- Next, select the PARAMETER (Sensor or Temperature) that drives the relay if either Alarm or Control is selected. If Wash is selected, the relay operates as a timer.

If ALARM is selected, the following activation options can be programmed in the ACTIVATION menu.

ALARM Function	Edit Range	Default Setting
Set Low Alarm	Min to Max scale	Zero or most negative reading
Set High Alarm	Min to Max scale	Highest reading
Set Low Deadband	0 to 14 pH	0 pH
Set High Deadband	0 to 14 pH	0 pH
Set Off-Delay	0 to 999 seconds	0 seconds
Set On-Delay	0 to 999 seconds	0 seconds

If CONTROL is selected, the following activation options can be programmed in the ACTIVATION menu.

ALARM Function	Edit Range	Default Setting
Set Phase	High or Low	High
Set Setpoint	Min to Max scale	Highest reading
Set Deadband	0 to 14 pH	0 pH
Set Off-Delay	0 to 999 seconds	0 seconds
Set On-Delay	0 to 999 seconds	0 seconds

If WASH is selected, the following activation options can be programmed in the ACTIVATION menu.

ALARM Function	Edit Range	Default Setting
Set Interval	0.0 to 999.9 minutes	0.0 minutes
Set Duration	0 to 999 seconds	10 seconds
Set Off Delay	0 to 999 seconds	0 seconds

Navigation from the Measure Menu:

1. Press MENU to display the Main Menu.
2. Scroll with the UP/DOWN arrows to view RELAY, RELAY A or RELAY B.
3. Press ENTER to select the desired relay.
4. Scroll with the UP/DOWN arrows to view FUNCTION
5. Press ENTER to select Function and use the UP/DOWN arrows to select Alarm, Control or Wash.
6. Press ENTER to select Alarm, Control or Wash. Press ESC to leave the setting unchanged.
7. Scroll with the UP/DOWN arrows to SET PARAMETER (unless Wash was selected).
8. Press ENTER to select SET PARAMETER and use the Up/DOWN arrows to select SENSOR or TEMPERATURE to drive the relay.
9. Press ENTER to select Sensor or Temperature. Press ESC to leave the setting unchanged.
10. Scroll with the UP/DOWN arrows to SET ACTIVATION.
11. Press ENTER to select SET ACTIVATION and use the UP/DOWN arrows to scroll the list of activation options. Select an option with the ENTER key. Edit the selected option with the UP/DOWN arrows. Press ENTER to select the edited option or press ESC to leave the option unchanged.

10. HELP MENU

The help menu displays the product name and the firmware version of the AV88.

Enter the Menu with the MENU key. Scroll the menu options with the UP/DOWN arrows. The Help menu is second to last. Press ENTER to select the HELP menu.

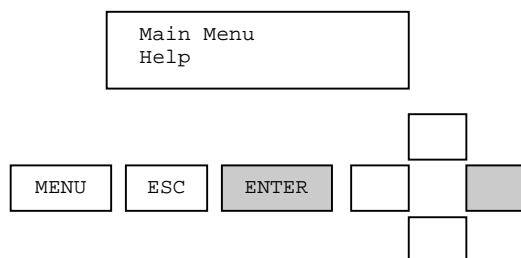

Press ENTER again to select the "About" menu.

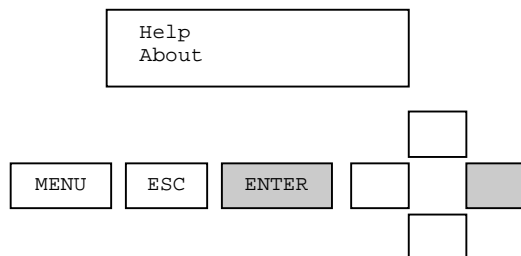

View the AV88 firmware version number.

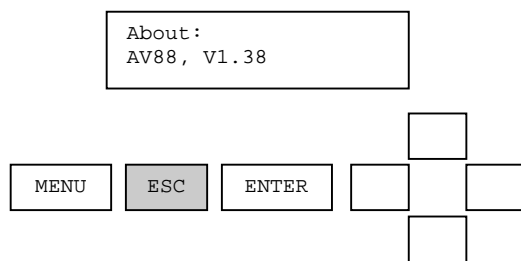

11. LIMITED WARRANTY

AV88 WARRANTY/REPLACEMENT PLAN

Thermo Fisher Scientific warrants its AV88 Local Display against material and workmanship defect for a period of one year from the date of shipment.

In the event that a defect is discovered during the warranty period, Thermo Fisher Scientific agrees, at its option, to repair or replace the defective product. Any product repaired or replaced under this warranty will be warranted only for the remainder of the original product warranty period.

This warranty does not apply to consumable products associated with this product including, but not limited to, chemical reagents and salt bridges.

Products may not be returned without authorization from Thermo Fisher Scientific. To obtain authorization, please call Thermo Fisher Scientific for a return material authorization number.

Limitations:

This warranty does not cover:

1. Damage caused by misuse, neglect (lack of appropriate maintenance), alteration, accident or improper application or installation.
2. Damage caused by any repair or attempted repair not authorized by Thermo Fisher Scientific.
3. Any product not used in accordance with the instructions furnished by Thermo Fisher Scientific.
4. Damage caused by acts of God, natural disaster, acts of war (declared or undeclared), acts of terrorism, work actions, or acts of any governmental jurisdiction.
5. Freight charges to return merchandise to Thermo Fisher Scientific.
6. Travel fees associated with on-site warranty repair.

This warranty is the sole expressed warranty made by Thermo Fisher Scientific in connection with its products. All other warranties, whether expressed or implied, including without limitation, the warranties of merchantability and fitness for a particular purpose, are expressly disclaimed.

The liability of Thermo Fisher Scientific shall be limited to the cost of the item giving rise to the claim. In no event shall Thermo Fisher Scientific be liable for incidental or consequential damages.

This warranty is the sole and complete warranty for Thermo Fisher Scientific. No person is authorized to make any warranties or representations on behalf of Thermo Fisher Scientific.

Thermo Fisher Scientific reserves the right to change or modify this warranty at any time.

12. TERMS AND CONDITIONS

Terms and Conditions of Sale

The following terms and conditions will be presumed acceptable unless changes are made in writing and accepted by both parties in a reasonable amount of time.

Any standard or boilerplate terms and conditions supplied with a written purchase order will not be applicable unless accepted in writing by both parties.

Quotations: All quotations shall be in writing. Written quotations shall be valid for 30 days from the date issued. Verbal quotations or price lists are not valid.

Pricing: All pricing is in **US Dollars**. Thermo Fisher Scientific reserves the right to change pricing without notice.

Terms: Payment terms are **net 30 days** from the date of invoice with approved credit. Thermo Fisher Scientific reserves the right to deny credit or revoke previously extended credit. Past due accounts are subject to interest charges. Other acceptable payment terms are cash, certified check, money order, credit card or letter of credit confirmed by any United States of America bank. Other payment terms are not valid unless accepted in writing.

Sales taxes shall be included on the invoice unless a valid tax exemption certificate is supplied.

Return Material Authorization: Contact Thermo Fisher Scientific Customer Service for a Return Material Authorization (RMA) number. Items returned without an RMA number will be rejected.

All returned merchandise must be in unused, resalable condition, and must not be contaminated with hazardous materials.

Cancelled orders must be returned within 30 days of the date on the invoice and shall be subject to expenses incurred that may include, but are not limited to, inspection and restocking fees. Items returned within 60 days shall be subject to a restocking charge that is equal to 15% of the purchase price. Items returned after more than 60 days shall be subject to a restocking charge equal to 25% of the purchase price. Thermo Fisher Scientific reserves the right to reject any return that is not under warranty after 60 days. Non-stock items are normally not returnable.

Transportation: Orders are shipped FOB Thermo Fisher Scientific, or factory, by the most efficient means available. Appropriate charges, such as freight and insurance will be added to invoices. All shipments will be insured. Goods damaged in shipment must be reported by the recipient to the freight carrier for claims.

Thermo Fisher Scientific

Environmental Instruments

Process Water Instruments



North America

166 Cummings Center
Beverly, MA 01915 USA
Toll Free: 1-800-225-1480
Tel: 1-978-232-6000
Dom. Fax: 1-978-232-6015
Int'l Fax: 978-232-6031

Europe

P.O. Box 254, 3860 AG Nijkerk
Wallerstraat 125K, 3862 BN Nijkerk,
Netherlands
Tel: (31) 033-2463887
Fax: (31) 033-2460832

Asia Pacific

Blk 55, Ayer Rajah Crescent
#04-16/24, Singapore 139949
Tel: 65-6778-6876
Fax: 65-6773-0836

www.thermo.com/processwater

© 2009 Thermo Fisher Scientific Inc. All rights reserved.

258476-001 Rev. A 01-09